



8-750-002-316

Bosch Smart Home Light/shutter control unit II

Product description

The product is suitable for controlling shutters, sun blinds and Venetian blinds. Alternatively, one or two lamps or other consumers can be switched on and off independently of each other. The module measures the power consumption of connected lamps and consumers.

Description of the symbols



Caution!
Note about hazards



Note:
Additional
important information



Note about the installation video

⚠ Safety instructions

- ▶ The device is not a toy! Do not allow children to play with it. Never leave the packaging material lying around unattended. Plastic film and small parts may pose a danger to children.
- ▶ When remotely or automatically controlling a device, it is not always possible to guarantee that commands are actually executed or that the correct device status is displayed in the app and on other Smart Home display devices because of external circumstances. This may lead to material damage and/or personal injury. Therefore, you must ensure to the greatest extent possible that no person is endangered at the time of remote operation or automated control. Please take special care when setting up or adjusting the remote control or when using the automated control and check the desired functionality at regular intervals.
- ▶ A remote control or automated control system carries a risk that shutters / Venetian blinds / sun blinds are lowered out of the operator's sight and direct sphere of influence. This unsupervised lowering of shutters / Venetian blinds / sun blinds can result in personal injury (including crushing injuries) or property damage. Therefore, you must ensure to the greatest extent possible that no people or objects are in the travel path of the shading elements being controlled. Only use the module in combination with

shutters / Venetian blinds / sun blinds which are equipped with obstacle detection or for which at least a comparable level of protection with regard to crushing injuries is ensured by means of other design features. Always consult an expert for this assessment and for the installation of any structural safety measures which may be required.

- ▶ Do not open up the device. It does not contain any parts to be maintained by the user. If a fault occurs, have the device checked by a specialist.
- ▶ We accept no liability for material damage or personal injury which is caused by improper use or failure to observe the safety instructions. In these cases, any guarantee claim becomes void! We accept no liability for consequential damage.
- ▶ For safety and approval reasons (CE/UKCA), the device may not be modified and/or no changes may be made to the device without authorisation.
- ▶ In the light control unit function, the model is only suitable for controlling electric lighting.
- ▶ In the shutter control unit function, the module is only suitable for controlling shutters, sun blinds and Venetian blinds.
- ▶ Any use other than that which is described in the user manual is considered improper and leads to the exclusion of guarantee and liability.
- ▶ The device is not suitable for disconnection.

- ▶ Do not use the device if it has damage visible from the outside, for example, to the housing, control elements or connection sockets, or if it has a malfunction. If in doubt, please contact our service team.
- ▶ Only operate the device indoors and do not expose it to moisture, vibrations, constant sunlight or other sources of heat, extreme cold temperatures and mechanical stress.
- ▶ Only use the device together with original components and recommended products from Bosch partners.

i Notes

- ▶ The range within buildings can differ significantly from the range in open spaces. In addition to the transmitting power and the receiving properties of the receiver, environmental factors such as humidity, as well as the local structural situation, play an important role.
 - ▶ The device is only suitable for use in residential environments.
 - ▶ The device is only intended for private use.
- ▶** You can also use the explanatory video and additional information on our website as an additional aid for mounting, installing, starting up and restoring the factory settings on your Bosch Smart Home light control unit:
- www.bosch-smarthome.com/rom/light-shutter-module-2**

Product overview

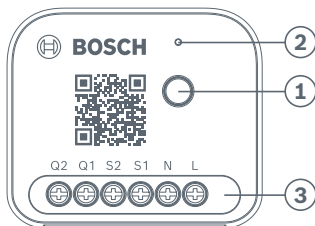







Item	Description
1	System button
2	Status LED
3	Terminals

The status LED (2) shows the status of the light/shutter module using flashing codes.

Status LED	Device status	Recommended action
Flashes orange	Tuning mode (is active) or device is communicating with the controller	Please wait
Flashes green	Tuning mode (successful) or process confirmed	
Flashes red	Tuning mode (not successful) or process failed	If this is the first tuning attempt, please try again. Otherwise reset the device to the factory settings and contact the service department if necessary.
Flashes red 6x (long)	The device is defective	Please contact support.

Notes regarding installation

-  The standards and directives applicable in your country must be observed during planning, set-up, operation and maintenance.
-  A 230 volt alternating current power supply is required for this product (there must be a phase and neutral conductor).
-  The product is only intended for fixed installation in in-wall switch boxes with a minimum depth of 50 mm and a screw distance of 60 mm (in accordance with DIN 49073-1) in indoor areas.
-  When connecting the device terminals, ensure that permitted wires and wire cross sections are used.
-  The consumers connected to the relay outputs must have sufficient insulation.
-  Observe the technical data, in particular the maximum permissible switching power of the relay and the type of consumers to be connected, before connecting a consumer (see technical data at the end of these instructions). The device should only be loaded to the specified power limit.
-  Overloading may result in destruction of the device, fire or an electric shock.

- ⚠ The power circuit to which the device and the load are connected must be secured with a circuit breaker in accordance with EN 60898-1 (trigger characteristics B or C, max. 16 A rated current, min. 6 kA breaking capacity, energy limitation class 3). Installation guidelines in accordance with the applicable national standards, e.g. VDE 0100 or HD384 or IEC 60364, must be observed. The circuit breaker must be easily accessible for the user and labelled as a disconnecter for the device.
- ⚠ The device is part of the building installation. The standards and directives applicable in your country must be observed during planning and set-up. Operation of the device is only permitted at 230 V/50 Hz AC voltage. Work on the 230 V network may only be carried out by an electrician (relevant standards and directives of your country). The applicable accident prevention regulations must be observed here. To avoid an electric shock on the device, please switch off the mains power. Failure to observe the installation instructions may result in fire or other hazards.

Installation

- i** The module can be used to control shutters / sun blinds / Venetian blinds or to control lighting.
- i** You must connect the module according to your desired purpose, then link it with the Smart Home controller and configure the purpose (shading or lighting) in the app.
- !** Incorrect configuration can lead to a defect with the connected consumers.
- i** The configuration, shading or lighting, is stored in the device and can only be cancelled by resetting the device to factory settings.
- i** If the device has not been configured for shading or light, the inputs S1/S2 do not issue any switching commands.
- !** Ensure that the terminal area does not come into contact with the metal parts of the installed device.
- !** The module may only be used outdoors with the corresponding protective housings (IP66).

Installation/ Configuration as a shading module

⚠ Before you start: Be sure to shut off the power circuit breaker!

Connect the controls in accordance with the connection diagram below:

Motor connection diagram

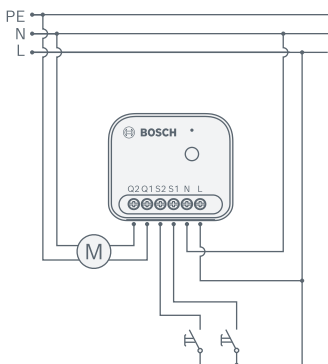

Connection

Description

L	External conductor
N	Neutral conductor
S1	Up switch
S2	Down switch
Q1	Motor up connection
Q2	Motor down connection
PE	Earth conductor

- i** The end positions of the drive must have already been set up / configured in advance. To do this, follow the instructions on your drive.
- i** If the module has not been paired with the Smart Home controller and configured with the shading function, the inputs S1/S2 do not trigger any movement.

If the module is connected correctly, switch the fuse back on.

Installation/ Configuration as a lighting module

⚠ Before you start: Be sure to shut off the power circuit breaker!

Connect the controls in accordance with the connection diagram below:

Activation/deactivation

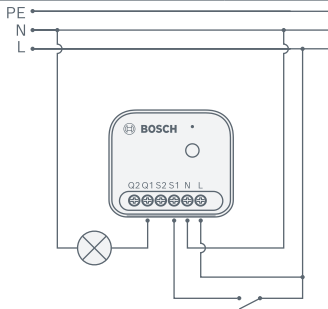

Connection

Description

L	External conductor
N	Neutral conductor
S1	Switch
S2	-
Q1	Lamp
Q2	-
PE	Earth conductor

- ⚠ If the module has not been paired with the Smart Home controller and configured with the light control unit function, the inputs S1/S2 do not trigger any switch commands.

Multiway switching

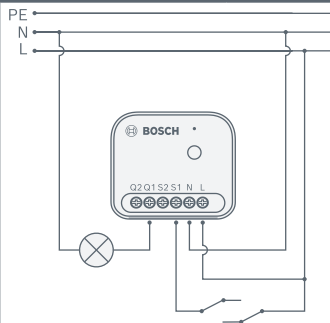

Connection

Description

L	External conductor
N	Neutral conductor
S1	Switch
S2	-
Q1	Lamp
Q2	-
PE	Earth conductor

You can use the module together with switches. For the device to function correctly, it must be paired with the Smart Home controller and the corresponding configuration must have been carried out in the app.

Connection of 2 lamps

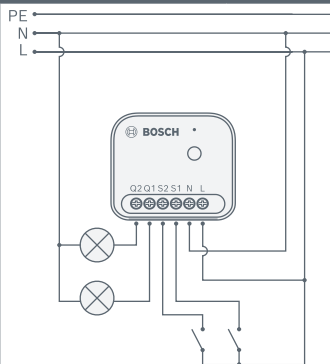

Connection

Description

L	External conductor
N	Neutral conductor
S1	Switch 1
S2	Switch 2
Q1	Lamp 1
Q2	Lamp 2
PE	Earth conductor

If the module is connected correctly, switch the fuse back on.

Start-up / tuning

Ensure that you have a Bosch Smart Home controller and the Bosch Smart Home app and have successfully configured both. Now start the Bosch Smart Home app and select “Add new device”. Follow the instructions in the app. Once the module has been switched on via the fuse, it is in tuning mode for 3 minutes. Tuning mode can be started on an unlinked module by pressing the system button (1) again or a connected switch (S1/S2).

Resetting to factory settings

You can reset the device to its factory settings as follows:

Press the system button (1) and hold it for approx. 4 seconds until the status LED (2) flashes orange quickly. Release the system button briefly and press it again until the LED lights green.

The device then restarts. Please note that it can take a few seconds until the module is ready for operation again.

⚠ WARNING Risk of electric shock.

Follow the rules for live working. Only press the system button with an isolated tool in accordance with EN IEC 60900. Not observing these instructions can result in death or severe injuries. Work on the 230 V network may only be carried out by an electrician.

i When resetting to factory settings, the settings and information are only lost from the device and not from the Bosch Smart Home controller.

- i** To re-configure the device, first delete it in the device management section of the Bosch Smart Home app and then add it again in the usual configuring process.
- i** The module settings, whether it is used for shading or for light, are deleted after the module is reset to factory settings. The desired use of the module is only possible after reconfiguring it via the app. If this is not done, no movement or switching commands are issued via the switches connected via S1/S2.

Maintenance and cleaning

The device does not require maintenance. Leave any repairs to a specialist.

Simplified declaration of conformity

CE Robert Bosch Smart Home GmbH hereby declare that the radio equipment type Bosch Smart Home BMCT-SLZ corresponds with the directive 2014/53/EU. The complete text of the EU declaration of conformity is available via the following web address:
<https://eu-doc.bosch.com>

**UK
CA** Robert Bosch Smart Home GmbH hereby declares that the radio system type BMCT-SLZ complies with Regulation 2017. The full text of the declaration of conformity is available at the following internet address:
<https://gb-doc.bosch.com>

Environmental protection and disposal





Electrical or electronic devices which are no longer usable must be collected separately and disposed of via an environmentally friendly recycling facility (European Directive on Waste Electrical and Electronic Equipment). Use your country's specific return and collection systems when disposing of waste electrical or electronic devices.

Open source software

This Bosch Smart Home product uses open-source software. License information for the components used can be found in the attached documents.







Technical data

Device type designation	BMCT-SLZ
Protection type	IP20
Protection class	II
Device protection	Thermal cutoff
Ambient temperature	-20 °C ... +50 °C
Dimensions (W × H × D)	40.5 × 47 × 22 mm
Weight	42 g
Radio frequency band	2.4 – 2.4835 GHz
Radio protocol	ZigBee 3.0
Max. transmitting power	10 mW
Radio range in the open	< 70 m
Software class	A
Receiver category	2
Supply voltage	230 V _{AC} /50 Hz
Power consumption in sleep mode	< 0.5 W
Cable type and cross section	Rigid and flexible cable, 0.75 – 2.5 mm ²
Max. switching power	
	2 A, cos φ 0,85~1
	2 x 200 W, cos φ 0,85
	2 x 500 W

Measurement precision	± 3 W at < 100 W / ± 3 % at > 100 W
Measurement category	CAT III

Technical modifications reserved

Symbol description

	Motors
	LED
	Electronic transformer for low-voltage incandescent lamps
	Fluorescent lamps
	Iron core transformer for low-voltage incandescent lamps
	Incandescent lamps

Service information

 Robert Bosch Smart Home GmbH
Schockenriedstraße 17
70565 Stuttgart-Vaihingen
Germany

 service@bosch-smarthome.com

 www.bosch-smarthome.com/service