

THS 42/18V P4A

Art. 14732

**EN Operator's manual**  
Telescopic Battery Hedge Trimmer

---

<p><b>DE Produkthaftung</b> Wir weisen ausdrücklich darauf hin, dass wir in Übereinstimmung mit dem Produkthaftungsgesetz nicht für Schäden haften, die durch unsere Produkte entstehen, wenn diese unsachgemäß und nicht durch einen von uns autorisierten Servicepartner repariert wurden oder wenn keine Original GARDENA Teile oder von uns zugelassene Teile verwendet wurden.</p>
<p><b>EN Product liability</b> In accordance with the German Product Liability Act, we hereby expressly declare that we accept no liability for damage incurred from our products where said products have not been properly repaired by a GARDENA-approved service partner or where original GARDENA parts or parts authorised by GARDENA were not used.</p>
<p><b>FR Responsabilité</b> Conformément à la loi relative à la responsabilité du fait des produits défectueux, nous déclarons expressément par la présente que nous déclinons toute responsabilité pour les dommages résultant de nos produits, si lesdits produits n'ont pas été correctement réparés par un partenaire d'entretien agréé GARDENA ou si des pièces d'origine GARDENA ou des pièces agréées GARDENA n'ont pas été utilisées.</p>
<p><b>NL Productaansprakelijkheid</b> Conform de Duitse wet inzake productaansprakelijkheid verklaren wij hierbij uitdrukkelijk dat wij geen aansprakelijkheid aanvaarden voor schade ontstaan uit onze producten waarbij deze producten niet zijn gerepareerd door een GARDENA-erkende servicepartner of waarbij geen originele GARDENA-onderdelen of onderdelen die door GARDENA zijn goedgekeurd zijn gebruikt.</p>
<p><b>SV Produktansvar</b> I enlighet med tyska produktansvarslagar förklarar vi härmed uttryckligen att vi inte åtar oss något ansvar för skador som orsakas av våra produkter där produkterna inte har genomgått korrekt reparation från en GARDENA-godkänd servicepartner eller där originaldelar från GARDENA eller delar godkända av GARDENA inte använts.</p>
<p><b>DA Produktansvar</b> I overensstemmelse med den tyske produktansvarslav erklærer vi hermed udtrykkeligt, at vi ikke påtager os noget ansvar for skader på vores produkter, hvis de pågældende produkter ikke er blevet repareret korrekt af en GARDENA-godkendt servicepartner, eller hvor der ikke er brugt originale GARDENA-reservedele eller godkendte reservedele fra GARDENA.</p>
<p><b>FI Tuotevastuu</b> Saksan tuotevastuulain mukaisesti emme ole vastuussa laitteiden vaurioista, jos korjauksia ei ole tehnyt GARDENAn hyväksymä huoltoliike tai jos niiden syynä on muuten kuin alkuperäisten GARDENA-varaosien tai GARDENAn hyväksymien varaosien käyttö.</p>
<p><b>IT Responsabilità del prodotto</b> In conformità con la Legge tedesca sulla responsabilità del prodotto, con la presente dichiariamo espressamente che decliniamo qualsiasi responsabilità per danni causati dai nostri prodotti qualora non siano stati correttamente riparati presso un partner di assistenza approvato GARDENA o laddove non siano stati utilizzati ricambi originali o autorizzati GARDENA.</p>
<p><b>ES Responsabilidad sobre el producto</b> De acuerdo con la Ley de responsabilidad sobre productos alemana, por la presente declaramos expresamente que no aceptamos ningún tipo de responsabilidad por los daños ocasionados por nuestros productos si dichos productos no han sido reparados por un socio de mantenimiento aprobado por GARDENA o si no se han utilizado piezas originales GARDENA o piezas autorizadas por GARDENA.</p>
<p><b>PT Responsabilidade pelo produto</b> De acordo com a lei alemã de responsabilidade pelo produto, declaramos que não nos responsabilizamos por danos causados pelos nossos produtos, caso os tais produtos não tenham sido devidamente reparados por um parceiro de assistência GARDENA aprovado ou se não tiverem sido utilizadas peças GARDENA originais ou peças autorizadas pela GARDENA.</p>
<p><b>PL Odpowiedzialność za produkt</b> Zgodnie z niemiecką ustawą o odpowiedzialności za produkt, niniejszym wyraźnie oświadczamy, że nie ponosimy żadnej odpowiedzialności za szkody poniesione na skutek użytkowania naszych produktów, w przypadku gdy naprawa tych produktów nie była odpowiednio przeprowadzana przez zatwierdzonego przez firmę GARDENA partnera serwisowego lub nie stosowano oryginalnych części GARDENA albo części autoryzowanych przez tę firmę.</p>
<p><b>HU Termékszavatosság</b> A németországi termékszavatossági törvénnyel összhangban ezennel nyomatékosan kijelentjük, hogy nem vállalunk felelősséget a termékeinkben keletkezett olyan károkért, amelyek valamely GARDENA által jóváhagyott szervizpartner által nem megfelelően végzett javításból adódtak, vagy amely során nem eredeti GARDENA alkatrészeket vagy a GARDENA által jóváhagyott alkatrészeket használtak fel.</p>
<p><b>CS Odpovědnost za výrobek</b> V souladu s německým zákonem o odpovědnosti za výrobek tímto výslovně prohlašujeme, že nepřijímáme žádnou odpovědnost za poškození vzniklá na našich výrobcích, kdy zmíněné výrobky nebyly řádně opraveny schváleným servisním partnerem GARDENA nebo kdy nebyly použity originální náhradní díly GARDENA nebo náhradní díly autorizované společností GARDENA.</p>
<p><b>SK Zodpovednosť za produkt</b> V súlade s nemeckými právnymi predpismi upravujúcimi zodpovednosť za výrobok týmto výslovne prehlasujeme, že nenesieme žiadnu zodpovednosť za škody spôsobené našimi výrobkami, v prípade ktorých neboli náležité opravy vykonané servisným partnerom schváleným spoločnosťou GARDENA alebo neboli použité diely spoločnosti GARDENA alebo diely schválené spoločnosťou GARDENA.</p>
<p><b>EL Ευθύνη προϊόντος</b> Σύμφωνα με τον γερμανικό νόμο περί Ευθύνης για τα Προϊόντα, με το παρόν δηλώνουμε ρητώς ότι δεν αποδεχόμαστε καμία ευθύνη για τυχόν ζημιές που προκύπτουν από τα προϊόντα μας εάν αυτά δεν έχουν επισκευαστεί σωστά από κάποιον εγκεκριμένο συνεργάτη επισκευών της GARDENA ή εάν δεν έχουν χρησιμοποιηθεί αυθεντικά εξαρτήματα GARDENA ή εξαρτήματα εγκεκριμένα από την GARDENA.</p>
<p><b>SL Odgovornost proizvajalca</b> V skladu z nemškimi zakoni o odgovornosti za izdelke, izrecno izjavljajo, da ne sprejemamo nobene odgovornosti za škodo, ki jo povzročijo naši izdelki, če teh niso ustrezno popravili GARDENINI odobreni servisni partnerji ali pri tem niso bili uporabljeni originalni GARDENINI nadomestni deli ali GARDENINIMI homologiranimi nadomestnimi deli.</p>
<p><b>HR Pouzdanost proizvoda</b> Sukladno njemačkom zakonu o pouzdanosti proizvoda, ovime izričito izjavljujemo kako ne prihvaćamo nikakvu odgovornost za oštećenja na našim proizvodima nastala uslijed neispravnog popravka od strane servisnog partnera kojeg odobrava GARDENA ili uslijed nekorištenja originalnih GARDENA dijelova ili dijelova koje odobrava GARDENA.</p>
<p><b>RO Răspunderea pentru produs</b> În conformitate cu Legea germană privind răspunderea pentru produs, declarăm în mod expres prin prezentul document că nu acceptăm nicio răspundere pentru defecțiunile suferite de produsele noastre atunci când acestea nu au fost reparate în mod corect de un atelier de service partener, aprobat de GARDENA, sau când nu au fost utilizate piese GARDENA originale sau piese autorizate de GARDENA.</p>
<p><b>BG Отговорност за вреди, причинени от стоки</b> Съгласно германския закон за отговорността за вреди, причинени от стоки, с настоящото изрично декларираме, че не носим отговорност за щети, причинени от нашите продукти, ако те не са били правилно ремонтирани от одобрен от GARDENA сервиз или ако не са използвани оригинални части на GARDENA или части, одобрени от GARDENA.</p>
<p><b>ET Tootevastutus</b> Vastavalt Saksamaa tootevastutusseadusele deklareerime käesolevaga selgesõnaliselt, et me ei kanna mingisugust vastutust meie toodetest tingitud kahjude eest, kui need tooted ei ole korrektselt parandatud GARDENA heakskiidetud hoolduspartneri poolt või kui parandamisel ei ole kasutatud GARDENA originaalosi või GARDENA volitatud osi.</p>
<p><b>LT Gaminio patikimumas</b> Mes aiškiai pareiškiame, kad, atsižvelgiant į Vokietijos gaminių patikimumo įstatymą, neprisiimame atsakomybės dėl bet kokios žalos, patirtos dėl mūsų gaminių, jeigu jie buvo netinkamai taisomi arba jų dalys buvo pakeistos neoriginaliomis GARDENA dalimis ar nepatvirtintomis dalimis, arba jeigu remonto darbai buvo atlikti ne GARDENA techninės priežiūros centro specialistų.</p>
<p><b>LV Atbildība par produkcijas kvalitāti</b> Saskaņā ar Vācijas likumu par atbildību par produkcijas kvalitāti ar šo mēs paziņojam, ka neuzņemamies atbildību par bojājumiem, kas radušies, lietojot mūsu izstrādājumus, kuru remontu nav veicis uzņēmuma GARDENA apstiprināts apkopes partneris vai kuru remontam netika izmantotas oriģinālās GARDENA detaļas vai detaļas, kuru lietošanu apstiprinājis uzņēmums GARDENA.</p>

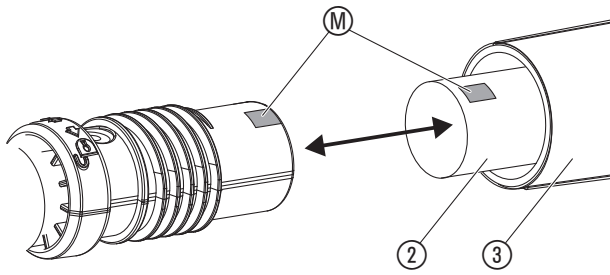
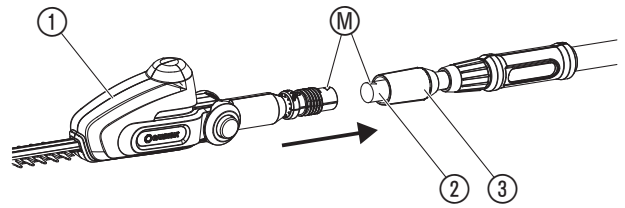
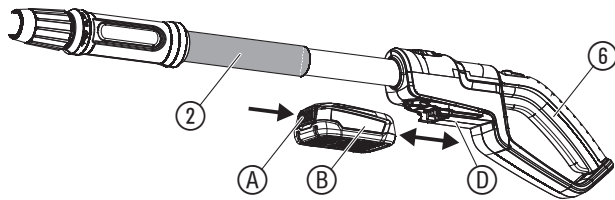
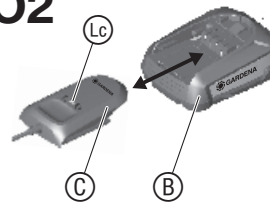
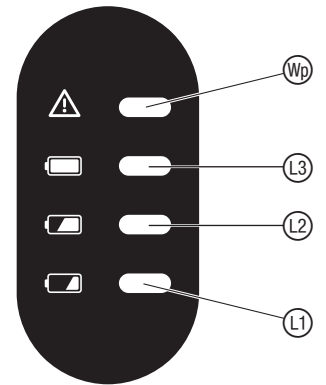
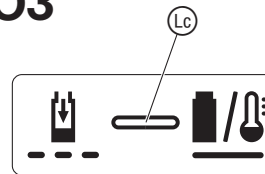
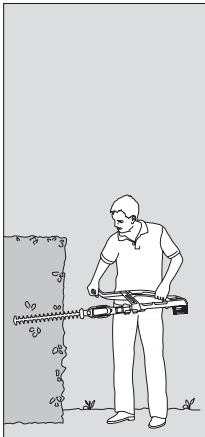
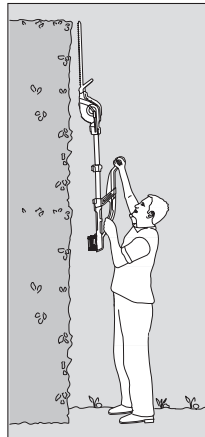
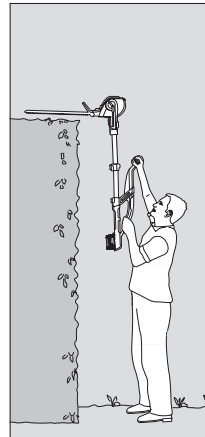
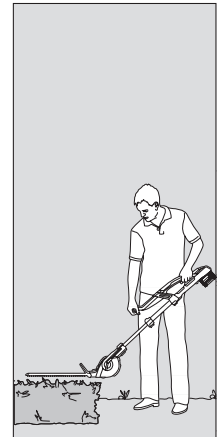
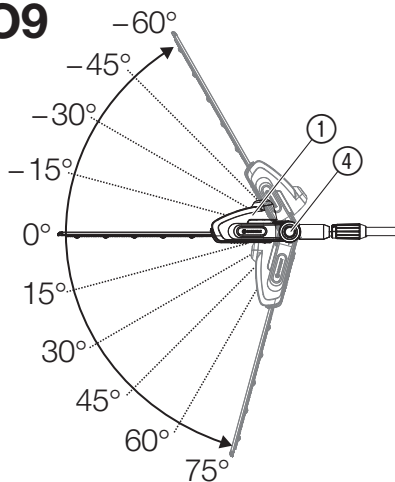
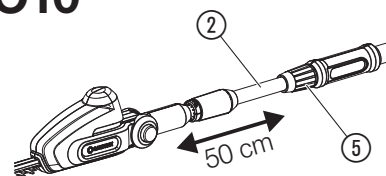
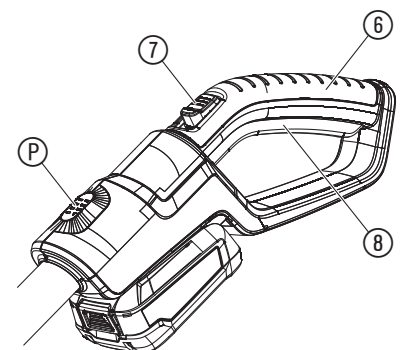
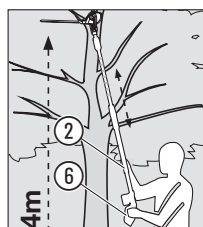
**A1****A2****O1****O2****O4****O3****O5****O6****O7****O8****O9****O10****O12****O11**

## EN Telescopic Battery Hedge Trimmer

1. SAFETY .....	9
2. ASSEMBLY .....	12
3. OPERATION .....	12
4. MAINTENANCE .....	12
5. STORAGE .....	13
6. TROUBLESHOOTING .....	13
7. TECHNICAL DATA .....	13
8. ACCESSORIES .....	14
9. SERVICE/WARRANTY .....	14

### Translation of the original instructions.



This product is not intended for use by persons (including children) with reduced physical, sensory or mental capabilities, or lack of experience and knowledge, unless they have been given supervision or instruction concerning use of the product by a person responsible for their safety. Children should be supervised to ensure that they do not play with the product. The use of this product by young people under the age of 16 is not recommended.

### Intended use:

The **GARDENA Teleskopik Hedge Trimmer** is intended to cut hedges, shrubs and grass coverings in private domestic gardens and allotments. The product is not intended for long term use.



**DANGER! Risk of injury!**

→ Do not use the product to cut lawns/lawn edges, to chop up material or to make compost. Do not use for pond care.

## 1. SAFETY

### IMPORTANT!

Read the operator's manual carefully before use and keep for future reference.

#### Symbols on the product:



Read operator's manual.



Danger – Keep hands away from blade.



Do not expose to rain.



For the charger:  
Remove plug from the mains immediately if the cable is damaged or cut.



Wear eye and ear protection.



Always wear a hard hat.



Remove the Battery before cleaning or maintenance.



**Risk of fatal injury due to electric shock!**  
Keep at least 10 m away from electricity lines.

### General safety warnings

#### General machine safety warnings



#### WARNING!

Read all safety warnings, instructions, illustrations and specifications provided with this machine. Failure to follow the warnings and instructions may result in electric shock, fire and/or serious injury.

Save all warnings and instructions for future reference.

The term "machine" in the warnings refers to your mains operated (corded) machine or battery operated (cordless) machine.

#### 1) Work area safety

- a) **Keep work area clean and well lit.** Cluttered or dark areas invite accidents.
- b) **Do not operate machines in explosive atmospheres, such as in the presence of flammable liquids, gases or dust.**  
*Machines create sparks which may ignite the dust or fumes.*
- c) **Keep children and bystanders away while operating a machine.**  
*Distractions can cause you to lose control.*

#### 2) Electrical safety

- a) **Machine plugs must match the outlet. Never modify the plug in any way. Do not use any adaptor plugs with earthed (grounded) machines.**  
*Unmodified plugs and matching outlets will reduce risk of electric shock.*
- b) **Avoid body contact with earthed or grounded surfaces, such as pipes, radiators, ranges and refrigerators.** There is an increased risk of electric shock if your body is earthed or grounded.
- c) **Do not expose machines to rain or wet conditions.**  
*Water entering a machine will increase the risk of electric shock.*
- d) **Do not abuse the cord. Never use the cord for carrying, pulling or unplugging the machine. Keep cord away from heat, oil, sharp edges or moving parts.**  
*Damaged or entangled cords increase the risk of electric shock.*
- e) **When operating a machine outdoors, use an extension cord suitable for outdoor use.**  
*Use of a cord suitable for outdoor use reduces the risk of electric shock.*
- f) **If operating a machine in a damp location is unavoidable, use a residual current device (RCD) protected supply.**  
*Use of an RCD reduces the risk of electric shock.*

#### 3) Personal safety

- a) **Stay alert, watch what you are doing and use common sense when operating a machine. Do not use a machine while you are tired or under the influence of drugs, alcohol or medication.** A moment of inattention while operating machines may result in serious personal injury.
- b) **Use personal protective equipment. Always wear eye protection.**  
*Protective equipment such as dust mask, non-skid safety shoes, hard hat, or hearing protection used for appropriate conditions will reduce personal injuries.*
- c) **Prevent unintentional starting. Ensure the switch is in the OFF-position before connecting to power source and/or battery pack, picking up or carrying the machine.**  
*Carrying machines with your finger on the switch or energising machines that have the switch on invites accidents.*
- d) **Remove any adjusting key or wrench before turning the machine on.**  
*A wrench or a key left attached to a rotating part of the machines may result in personal injury.*
- e) **Do not overreach. Keep proper footing and balance at all times.**  
*This enables better control of the machine in unexpected situations.*
- f) **Dress properly. Do not wear loose clothing or jewellery. Keep your hair, clothing and gloves away from moving parts.**  
*Loose clothes, jewellery or long hair can be caught in moving parts.*
- g) **If devices are provided for the connection of dust extraction and collection facilities, ensure these are connected and properly used.**  
*Use of dust collection can reduce dust-related hazards.*
- h) **Do not let familiarity gained from frequent use of machines allow you to become complacent and ignore machine safety principles.**  
*A careless action can cause severe injury within a fraction of a second.*

#### 4) Machine use and care

- a) **Do not force the machine. Use the correct machine for your application.** The correct machine will do the job better and safer at the rate for which it was designed.
- b) **Do not use the machine if the switch does not turn it on and off.**  
*Any machine that cannot be controlled with the switch is dangerous and must be repaired.*
- c) **Disconnect the plug from the power source and/or the battery pack from the machine before making any adjustments, changing accessories, or storing machines.** Such preventive safety measures reduce the risk of starting the machine accidentally.

- d) **Store idle machines out of the reach of children and do not allow persons unfamiliar with the machine or these instructions to operate the machine.** Machines are dangerous in the hands of untrained users.
- e) **Maintain machines. Check for misalignment or binding of moving parts, breakage of parts and any other condition that may affect the machine's operation. If damaged, have the machine repaired before use.** Many accidents are caused by poorly maintained machines.
- f) **Keep cutting tools sharp and clean.** Properly maintained cutting tools with sharp cutting edges are less likely to bind and are easier to control.
- g) **Use the machine, accessories and tool bits etc. in accordance with these instructions, taking into account the working conditions and the work to be performed.** Use of the machine for operations different from those intended could result in a hazardous situation.
- h) **Keep handles and grasping surfaces dry, clean and free from oil and grease.** Slippery handles and grasping surfaces do not allow for safe handling and control of the machine in unexpected situations.

#### 5) Battery tool use and care

- a) **Recharge only with the charger specified by the manufacturer.**  
*A charger that is suitable for one type of battery pack may create a risk of fire when used with another battery pack.*
- b) **Use machines only with specifically designated battery packs.**  
*Use of any other battery packs may create a risk of injury and fire.*
- c) **When battery pack is not in use, keep it away from other metal objects, like paper clips, coins, keys, nails, screws or other small metal objects, that can make a connection from one terminal to another.** Shorting the battery terminals together may cause burns or a fire.
- d) **Under abusive conditions, liquid may be ejected from the battery; avoid contact. If contact accidentally occurs, flush with water. If liquid contacts eyes, additionally seek medical help.**  
*Liquid ejected from the battery may cause irritation or burns.*
- e) **Do not use a battery pack or tool that is damaged or modified.**  
*Damaged or modified batteries may exhibit unpredictable behavior resulting in fire, explosion or risk of injury.*
- f) **Do not expose a battery pack or tool to fire or excessive temperature.**  
*Exposure to fire or temperature above 130 °C may cause explosion.*
- g) **Follow all charging instructions and do not charge the battery pack or tool outside the temperature range specified in the instructions.**  
*Charging improperly or at temperatures outside the specified range may damage the battery and increase the risk of fire.*

#### 6) Service

- a) **Have your machine serviced by a qualified repair person using only identical replacement parts.**  
*This will ensure that the safety of the machine is maintained.*
- b) **Never service damaged battery packs.** Service of battery packs should only be performed by the manufacturer or authorised service providers.

#### Hedge trimmer safety warnings

- a) **Keep all parts of the body away from the blade. Do not remove cut material or hold material to be cut when blades are moving.**  
*Blades continue to move after the switch is turned off. A moment of inattention while operating the hedge trimmer may result in serious personal injury.*
- b) **Carry the hedge trimmer by the handle with the blade stopped and taking care not to operate any power switch.**  
*Proper carrying of the hedge trimmer will decrease the risk of inadvertent starting and resultant personal injury from the blades.*
- c) **When transporting or storing the hedge trimmer, always fit the blade cover.** Proper handling of the hedge trimmer will decrease the risk of personal injury from the blades.
- d) **When clearing jammed material or servicing the unit, make sure all power switches are off and the battery pack is removed or disconnected.** Unexpected actuation of the hedge trimmer while clearing jammed material or servicing may result in serious personal injury.
- e) **When clearing jammed material or servicing the unit, make sure all power switches are off and the lock-off is in the locked position.** Unexpected actuation of the hedge trimmer while clearing jammed material or servicing may result in serious personal injury.
- f) **Hold the hedge trimmer by insulated gripping surfaces only, because the blade may contact hidden wiring.**  
*Blades contacting a "live" wire may make exposed metal parts of the hedge trimmer "live" and could give the operator an electric shock.*
- g) **Keep all power cords and cables away from cutting area.**  
*Power cords or cables may be hidden in hedges or bushes and can be accidentally cut by the blade.*
- h) **Do not use the hedge trimmer in bad weather conditions, especially when there is a risk of lightning.**  
*This decreases the risk of being struck by lightning.*

#### Extended-reach hedge trimmer safety warnings

- a) **To reduce the risk of electrocution, never use the extended-reach hedge trimmer near any electrical power lines.** Contact with or use near power lines may cause serious injury or electric shock resulting in death.
- b) **Always use two hands when operating the extended-reach hedge trimmer.** Hold the extended-reach hedge trimmer with both hands to avoid loss of control.
- c) **Always use head protection when operating the extended-reach hedge trimmer overhead.** Falling debris can result in serious personal injury.

Search hedges and bushes for hidden objects (e.g. wire fences and hidden wires). The use of a residual current device (RCD) with a trip current of 30 mA or less is recommended.

Hold the hedge trimmer with both hands on both handles.

The hedge trimmer is intended for use when the user is standing on the ground and not on a ladder or other unstable surface.

Before using the hedge trimmer, make sure that the locking devices of all moving parts (e.g. the extended shaft and the pivot element) are in the locked position.

### Additional safety warnings

#### Battery safety



**Read all the safety and general instructions.**

Failure to observe the safety and general instructions may result in electric shock, fire and/or serious injury.

**Store these instructions in a safe place.** Only use the charger if you can fully evaluate all functions and carry them out without restrictions, or if you have received corresponding instructions.

→ **Supervise children during use, cleaning and maintenance.**

This will ensure that children do not play with the charger.

→ **Charge only lithium-ion batteries of the POWER FOR ALL system type PBA 18V with a capacity of 1.5 Ah or more (5 battery cells or more).**

**The battery voltage must match the battery charging voltage of the charger. Do not charge any nonrechargeable batteries.**

Otherwise there is a risk of fire and explosion.

→ **Do not expose the charger to rain or wet conditions.**

Water entering a power tool will increase the risk of electric shock.

→ **Keep the charger clean.** Dirt poses a risk of electric shock.

→ **Always check the charger, cable and plug before use. Stop using the charger if you discover any damage. Do not open the charger yourself, and have it repaired only by a qualified specialist using only original replacement parts.**

Damaged chargers, cables and plugs increase the risk of electric shock.

→ **Do not operate the charger on an easily ignited surface (e.g. paper, textiles, etc.) or in a flammable environment.**

There is a risk of fire due to the charger heating up during operation.

→ In order to avoid safety hazards, if the power supply cord needs to be replaced, this must be done by GARDENA or by a customer service centre that is authorised to repair GARDENA power tools.

→ **Do not operate the product while it is charging.**

**Products sold in GB only:** Your product is fitted with an BS 1363/A approved electric plug with internal fuse (ASTA approved to BS 1362). If the plug is not suitable for your socket outlets, it should be cut off and an appropriate plug fitted in its place by an authorised customer service agent. The replacement plug should have the same fuse rating as the original plug. The severed plug must be disposed of to avoid a possible shock hazard and should never be inserted into a mains socket elsewhere.

→ **These safety warnings apply only for lithium-ion batteries of the POWER FOR ALL system PBA 18V.**

→ **Only use the battery with products of the POWER FOR ALL system manufacturers.** This is the only way in which you can protect the battery against dangerous overload.

→ **Recharge only with the charger specified by the manufacturer.**

A charger that is suitable for one type of battery pack may create a risk of fire when used with another battery pack.

→ **The battery is supplied partially charged.**

To ensure full battery capacity, fully charge the battery in the charger before using your power tool for the first time.

→ **Keep battery packs out of the reach of children.**

→ **Do not open the battery.** There is a risk of short-circuiting.

→ **In case of damage and improper use of the battery, vapours may be emitted. The battery can set alight or explode.**

Ensure the area is well ventilated and seek medical attention should you experience any adverse effects. The vapours may irritate the respiratory system.

→ **If used incorrectly or if the battery is damaged, flammable liquid may be ejected from the battery. Contact with this liquid should be avoided. If contact accidentally occurs, rinse off with water. If the liquid comes into contact with your eyes, seek additional medical attention.**

Liquid ejected from the battery may cause irritation or burns.

→ **If the battery is damaged liquid can be ejected and cover nearby surfaces. Check affected parts.**

Clean these parts or change them if necessary.

→ **Do not short-circuit the battery pack. When the battery pack is not in use, keep it away from other metal objects, like paper clips, coins, keys, nails, screws or other small metal objects, that can make a connection from one terminal to another.**

Shorting the battery terminals together may cause burns or a fire.

→ **The battery can be damaged by pointed objects such as nails or screwdrivers or by force applied externally.** An internal short circuit may occur, causing the battery to burn, smoke, explode or overheat.

→ **Never service damaged battery packs.** Service of battery packs should only be performed by the manufacturer or authorized service providers.

→ **Protect the battery against heat, e.g. against continuous intense sunlight, fire, dirt, water and moisture.**

There is a risk of explosion and short-circuiting.



→ **Only operate and store the battery at an ambient temperature between  $-20\text{ }^{\circ}\text{C}$  and  $+50\text{ }^{\circ}\text{C}$ .**

Do not leave the battery in your car in the summer, for example.

At temperatures of  $<0\text{ }^{\circ}\text{C}$  some devices may experience a loss of power.

→ **Only charge the battery at an ambient temperature which is between  $0\text{ }^{\circ}\text{C}$  and  $+45\text{ }^{\circ}\text{C}$ .**

Charging outside of this temperature range can increase the risk of damage to the battery and pose a fire hazard.

#### Electrical safety



**DANGER! Cardiac arrest!**

**This product makes an electromagnetic field while it operates. This field may under some conditions interfere with active or passive medical implants. To decrease the risk of conditions that can possibly injure or kill, we recommend persons with medical implants to speak with their physician and the medical implant manufacturer before you operate the product.**

Only connect charger to the AC voltage specified on the rating plate.

Under no circumstances should an earth be connected to any part of the product.

Do not use the product when a thunderstorm is approaching.

Disconnect the product from the mains and disconnect the battery if the product starts to vibrate abnormally. Check immediately. Excessive vibration can cause injury.

Protect the battery contacts from moisture.

#### Personal safety



**DANGER! Risk of suffocation!**

**Small parts can be easily swallowed. There is also a risk that the poly-bag can suffocate toddlers. Keep toddlers away when you assemble the product.**

Only use the product in the manner and for the functions described in these instructions. The operator or user is responsible for accidents or hazards occurring to other people or their property. Pay special attention to the hazard for third parties posed by the increased working radius when the telescopic tube is extended.



**DANGER!**

**When wearing hearing protection, and due to the noise produced by the product, the operator may not notice persons approaching.**

Always wear suitable clothing, gloves, and stout shoes.

Avoid contact to the oil of the blade in particular when you react allergic with it.

Check the areas where the hedge trimmer is to be used and remove any wires, hidden electrical cables and other foreign objects.

All adjustments (inclining the blade head, altering the length of the telescopic tube) have to be made with the sheath in place, and the Hedge Trimmer must not rest on the blade in the process.

Before using the machine and after any impact, check for signs of wear or damage.

Have the appropriate repair work carried out if necessary.

Never attempt to use an incomplete product or one with an unauthorised modification.

#### Power tool use and care

Know how to stop the product quickly in an emergency. Never hold the product by the protective cover.

Do not use the Hedge Trimmer if the protection equipment are damaged.

Do not use ladders whilst operating the hedge trimmer.

Always use the product when standing on solid ground.

Remove the battery:

- before leaving the hedge trimmer unattended for any period;
- before clearing a blockage;
- before checking, cleaning or working on the hedge trimmer;
- if you hit an object. Do not use your hedge trimmer until you are sure that the entire hedge trimmer is in a safe operating condition;
- if the hedge trimmer starts to vibrate abnormally. Check immediately. Excessive vibration can cause injury;
- before passing to another person.



**RISK OF INJURY!**

**Do not touch the blade.**

→ **When work is finished or interrupted, refit the protective cover.**

All nuts and screws must be firmly tightened to ensure a safe operating condition of the product.

If the product got hot during operation, let it cool down before storage.

The Hedge trimmer must not be stored over  $35\text{ }^{\circ}\text{C}$  or under direct exposure to sunlight.

Do not store the Hedge Trimmer in places with static electricity.

Beware of falling debris.

Only work in the daylight or when visibility is good.

## 2. ASSEMBLY



### DANGER! Risk of injury!

Cut injury when the product starts accidentally.

→ Remove the battery and slide the protective cover over the blade before you assemble the product.

### To assemble the telescopic handle [Fig. A1/A2]:

- Slide the telescopic tube ② into the motor unit ① until you reach the stop position. The two markings ④ must be opposite from each other.
- Tighten the grey nut ③.

## 3. OPERATION



### DANGER! Risk of injury!

Cut injury when the product starts accidentally.

→ Wait for the blade to stop, remove the battery and slide the protective cover over the blade before you adjust or transport the product.

### To charge the battery [Fig. O1/O2/O3]:



### CAUTION!

→ Note the mains voltage! The voltage of the power source must match the voltage specified on the rating plate of the charger.

For the GARDENA Battery Hedge Trimmer Art. 14732-55 there is no battery and no charger in the scope of delivery.

Thanks to the intelligent charging process, the charge condition of the battery is automatically detected and then charged up with the optimal charge current depending on battery temperature and voltage.

In this way, the battery is treated with care and remains permanently fully charged when it is stored in the charger.

- Push the locking button ④ and remove the battery ⑤ from the battery holder ⑥.
- Connect the battery charger ⑦ into a mains socket.
- Slide the battery charger ⑦ onto the battery ⑤.

When the battery charge indicator ⑧ at the charger flashes green the battery is being charged.

When the battery charge indicator ⑧ at the charger illuminates permanently green the battery is completely charged (Charging time, see 7. TECHNICAL DATA).

- Examine the charge status regularly while you charge.
- When the battery ⑤ is completely charged, you can disconnect the battery ⑤ from the charger ⑦.

### Meaning of the indication elements:

#### Indication on the charger:

**Flashing of the battery charge indicator ⑧** The charging procedure is indicated by flashing of the battery charge indicator ⑧.



**Note:** The charging procedure is only possible when the battery temperature is within the allowable charging temperature range, see 7. TECHNICAL DATA.

**Continuous lighting of the battery charge indicator ⑧**

**Continuous lighting** of the battery charge indicator ⑧ indicates that the battery is fully charged or that the temperature of the battery is not within the allowable charging temperature range and can therefore not be charged.



When the battery is not inserted, **continuous lighting** of the battery charge indicator ⑧ indicates that the mains plug is inserted in the socket outlet and that the battery charger is ready for operation.

**Battery charge status indication ⑨ on the product [Fig. O4/O12]:**  
After starting the product, the battery charge status indication ⑨ is displayed for 5 seconds.

Battery charge status	Battery charge status indication
67 – 100 % charged	①, ② and ③ illuminate green
34 – 66 % charged	① and ② illuminate green
11 – 33 % charged	① illuminates green
0 – 10 % charged	① flashes green

If the LED ① flashes green, the battery must be charged.

If the error LED ④ is illuminated or flashing, see 6. TROUBLESHOOTING.

### Work positions:

The hedge trimmer can be operated in 4 positions.

**Side trimming:** Telescopic tube retracted  
[Fig. O5]

**Vertical trimming at high level:** Telescopic tube extended  
[Fig. O6]

**Horizontal trimming at high level:** Motor unit tilted by 75°, telescopic tube extended  
[Fig. O7]

**Low trimming:** Motor unit tilted by –60°, telescopic tube extended  
[Fig. O8]

### To tilt the motor unit [Fig. O9]:

For trimming at high and low level, the motor unit ① can be tilted at an angle of 75° to –60° in 15° increments.

- Keep both orange buttons ④ pushed and tilt the motor unit ① in the desired direction.
- Release both orange buttons ④ and let the motor unit ① engage.

### To extend the telescopic tube [Fig. O10]:

For cutting at high and low heights, the telescopic pipe ② can be continuously extended by up to 50 cm.

- Loosen the orange nut ⑤.
- Extend the telescopic tube ② to the desired length.
- Tighten the orange nut ⑤ again.

### To start the hedge trimmer [Fig. O1/O11/O12]:



### DANGER! Risk of injury!

Risk of injury if the product does not stop when you release the start lever.

→ Do not bypass the safety devices or switches. For example do not attach the start lever to the handle.

### To start:

The product is provided with a two-switch safety device (start lever with starting lockout) to prevent the product from being turned on by accident.

- Put the battery ⑤ into the battery holder ⑥ until it audibly engages.
- Remove the protective cover from the blade.
- Hold the hedge trimmer with one hand on the insulated gripping surface on the telescopic tube ② and with the other hand on the handle ⑥.
- Slide the starting lockout ⑦ forward and pull the start lever ⑧.  
*The hedge trimmer starts and the battery charge status indication ⑨ is displayed for 5 seconds.*
- Release the starting lockout ⑦.

### To stop:

- Release the start lever ⑧.  
*The hedge trimmer stops.*
- Slide the protective cover over the blade.
- Push the locking button ④ and remove the battery ⑤ from the battery holder ⑥.

## 4. MAINTENANCE



### DANGER! Risk of injury!

Cut injury when the product starts accidentally.

→ Wait for the blade to stop, remove the battery and slide the protective cover over the blade before you maintain the product.

### To clean the Hedge Trimmer:



### DANGER! Risk of injury!

Risk of injury and risk of damage to the product.

→ Do not clean the product with water or with a water jet (in particular high-pressure water jet).

→ Do not clean with chemicals including petrol or solvents. Some can destroy critical plastic parts.

The airflow slots must always be clean.

1. Clean the hedge trimmer with a damp cloth.
2. Clean the airflow slots with a soft brush (do not use a screwdriver).
3. Lubricate the blade with a low viscosity oil (e. g. GARDENA Maintenance Oil Art. 2366).  
*Avoid contact with the plastic parts.*

#### To clean the battery and the battery charger:

Make sure that the surface and the contacts of the battery and the battery charger always are clean and dry before you connect the battery charger.

#### Do not use running water.

- **Battery charger:** Clean the contacts and the plastic parts with a soft and dry cloth.
- **Battery:** Occasionally clean the ventilation slots and the terminals on the battery using a soft brush that is clean and dry.

## 5. STORAGE

#### To put into storage:

#### The product must be stored away from children.

1. Slide the protective cover over the blade.
2. Remove the battery.
3. Charge the battery.
4. Clean the hedge trimmer, the battery and the battery charger (see 4. MAINTENANCE).
5. Store the hedge trimmer, the battery and the battery charger in a dry, enclosed and frost-free place.

#### Disposal:

(in accordance with RL2012/19/EC)



The product must not be disposed of to normal household waste. It must be disposed of in line with local environmental regulations.

#### IMPORTANT!

- Dispose of the product through or via your municipal recycling collection centre.

#### Disposal of the battery:



The GARDENA battery contains lithium-ion cells that should not be disposed of with normal household waste at the end of its life.

Li-ion

#### IMPORTANT!

- Dispose of the batteries through or via your municipal recycling collection centre.
1. Discharge the lithium-ion cells completely (contact the GARDENA Service).
  2. Protect the contacts on the lithium-ion cells against short circuits.
  3. Dispose of the lithium-ion cells properly.

## 6. TROUBLESHOOTING







**DANGER! Risk of injury!**

**Cut injury when the product starts accidentally.**

- Wait for the blade to stop, remove the battery and slide the protective cover over the blade before you troubleshoot the product.

Problem	Possible Cause	Remedy
Hedge trimmer can no longer be stopped	Start lever is stuck.	→ Remove the battery and loosen the start lever.
Hedge is not cleanly cut	Blade is blunt or damaged.	→ Let the blade replaced by the GARDENA Service.
Hedge trimmer vibrates severely	Blade is damaged.	→ Switch off the product and let the blade be replaced.
Hedge trimmer does not start or stops. LED  is flashing green [Fig. 04]	Battery is empty.	→ Charge the battery.

Problem	Possible Cause	Remedy
Hedge trimmer does not start or stops. Error-LED  is illuminated red [Fig. 04]	Battery temperature is outside the permissible temperature range.	→ Wait until the battery temperature is between 0 °C – + 45 °C again.
	There are drops of water or moisture between the battery contacts on the hedge trimmer.	→ Remove the water drops/moisture with a dry cloth.
	Engine is blocked.	→ Remove the obstacle. Start again.
Hedge trimmer does not start or stops. Error-LED  is flashing red [Fig. 04]	Product is defective.	→ Contact the GARDENA Service.
Hedge trimmer does not start or stops. Error-LED  is not illuminated [Fig. 04]	Battery is not put completely into the battery holder.	→ Put the battery completely into the battery holder until it audibly engages.
	Battery is defective.	→ Replace the battery.
	Product is defective.	→ Contact the GARDENA Service.
Charging is not possible. Battery charge indicator  is continuously illuminated [Fig. 03]	The battery is not connected (correctly).	→ Connect the battery to charger correctly.
	Battery contacts are dirty.	→ Clean the battery contacts (e. g. by connecting and disconnecting the battery several times. Replace the battery if necessary.
	Battery temperature is outside the permissible charging temperature range.	→ Wait until the battery temperature is between 0 °C – + 45 °C again.
	Battery is defective.	→ Replace the battery.
Battery charge indicator  is not illuminated [Fig. 03]	Mains plug of the charger is not (correctly) plugged in.	→ Insert the mains plug into the mains socket (completely).
	Socket outlet, mains cable or charger is defective.	→ Check the mains voltage. Let the charger be checked if necessary by an authorised specialist dealer or the GARDENA Service.



**NOTE: For any other malfunctions please contact the GARDENA service department. Repairs must only be done by GARDENA service departments or specialist dealers approved by GARDENA.**

## 7. TECHNICAL DATA

Telescopic Battery Hedge Trimmer	Unit	Value (Art. 14732)
Strokes	1/min	2100
Length of blade	cm	42
Tooth gap of blade	mm	16
Range of extension of the telescopic tube	cm	0 – 50
Weight (including battery)	kg	3.4
Sound pressure level $L_{pA}$ <sup>1)</sup> Uncertainty $k_{pA}$	dB (A)	72 3
Sound power level $L_{WA}$ <sup>2)</sup> : measured/guaranteed Uncertainty $k_{WA}$	dB (A)	87 / 90 3
Hand/arm vibration $a_{vhw}$ <sup>1)</sup> Uncertainty $k_{vhw}$	m/s <sup>2</sup>	1 1.5

Measuring process complying with: <sup>1)</sup> EN 62841-4-2 <sup>2)</sup> RL 2000/14/EC



**NOTE: The stated vibration emission value has been measured according to a standardized test procedure and can be used for comparison of one electric power tool with another. It can also be used for preliminary evaluation of exposure. The vibration emission value can vary during actual use of the electric power tool.**

System Battery PBA 18V 2.5Ah W-B	Unit	Value (Art. 14903)
Battery voltage	V (DC)	18
Battery capacity	Ah	2.5
Number of cells (Li-Ion)		5

Appropriate POWER FOR ALL system Battery Chargers: AL 18..CV.



<b>Battery Charger AL 1810 CV P4A</b>	<b>Unit</b>	<b>Value (Art. 14900)</b>
<b>Mains voltage</b>	V (AC)	220 – 240
<b>Mains frequency</b>	Hz	50 – 60
<b>Rated power</b>	W	26
<b>Battery charging voltage</b>	V (DC)	18
<b>Max. battery charging current</b>	mA	1000
<b>Battery charging time 80 %/ 97 – 100 % (approx.)</b>		
<b>PBA 18V 2.0Ah W-B</b>	min.	96 / 124
<b>PBA 18V 2.5Ah W-B</b>	min.	120 / 154
<b>PBA 18V 4.0Ah W-C</b>	min.	192 / 244
<b>Permitted charging temperature range</b>	°C	0 – 45
<b>Weight according to EPTA-Procedure 01:2014</b>	kg	0.17
<b>Protection class</b>	□ / II	

Appropriate POWER FOR ALL system Batteries: PBA 18V.

## 8. ACCESSORIES

<b>GARDENA Maintenance Oil</b>	Extends the life of the blade and the battery idling time.	<b>Art. 2366</b>
<b>GARDENA System Battery PBA 18V/45 P4A PBA 18V/72 P4A</b>	Battery for additional duration or for replacement.	<b>Art. 14903 Art. 14905</b>
<b>GARDENA Battery Quick Charger AL 1830 CV P4A</b>	Charger for fast charging the POWER FOR ALL system Batteries PBA 18V..W-..	<b>Art. 14901</b>

## 9. SERVICE/WARRANTY

### Service:

Please contact the address on the back page.

### Warranty statement:

In the event of a warranty claim, no charge is levied to you for the services provided.

GARDENA Manufacturing GmbH grants a warranty for all original GARDENA new products for two years from the date of original purchase from the retailer, provided that the devices have been for private use only. This manufacturer's warranty does not apply to products acquired second hand. This warranty includes all significant defects of the product that can be proved to be material or manufacturing faults. This warranty is fulfilled by supplying a fully functional replacement product or by repairing the faulty product sent to us free of charge; we reserve the right to choose between these options. This service is subject to the following provisions:

- The product has been used for its intended purpose as per the recommendations in the operating instructions.
- Neither the purchaser nor a third party has attempted to open or repair the product.
- Only Original GARDENA replacement parts and wear parts have been used for operation.
- Presentation of the receipt.

Normal wear and tear of parts and components (such as blades, blade fixing parts, turbines, light bulbs, V-belts/toothed belts, impellers, air filters, spark plugs), visual changes, wear parts and consumables are excluded from the warranty.

This manufacturer's warranty is limited to replacement and repair of products in accordance with the abovementioned conditions. The manufacturer's warranty does not constitute an entitlement to lodge other claims against us as a manufacturer, such as for damages. This manufacturer's warranty does **not**, of course, affect statutory and contractual warranty claims against the dealer/retailer.

The manufacturer's warranty is governed by the law of the Federal Republic of Germany.

In case of a warranty claim, please return the faulty product, together with a copy of the receipt and a description of the fault, with postage paid to the service address.

### Consumables:

The blade and excentric drive are consumables and are not included in the warranty.

<p><b>DE EU-Konformitätserklärung</b> Der Unterzeichnende bestätigt als Bevollmächtigter des Herstellers, der GARDENA Germany AB, PO Box 7454, S-103 92, Stockholm, Schweden, dass das (die) nachfolgende bezeichnete(n) Geräte(e) in der von uns in Verkehr gebrachten Ausführung die Anforderungen der harmonisierten EU-Richtlinien, EU-Sicherheitsstandards und produktspezifischen Standards erfüllen/erfüllen. Bei einer nicht mit uns abgestimmten Änderung des (der) Geräte(s) verliert diese Erklärung ihre Gültigkeit.</p>	<p><b>HU EU megfeleléségi nyilatkozat</b> Az alulírott, a GARDENA Germany AB, Pf. 7454, S-103 92, Stockholm, Svédország megbízotti minőségében megerősíti, hogy az általunk alábbi kivitelben forgalomba hozott, lent nevezett eszköz(ök) megfelel(nek) az uniós irányelvekkel összhangba hozott nemzeti előírások követelményeinek, az EU biztonsági szabványainak és a konkrét termékre vonatkozó szabványoknak. Az eszköz(ök)nek velünk egyeztetett módosítása esetén ez a nyilatkozat érvényét veszti.</p>
<p><b>EN EC Declaration of Conformity</b> The undersigned hereby certifies as the authorized representative of the manufacturer, GARDENA Germany AB, PO Box 7454, S-103 92, Stockholm, Sweden, that, when leaving our factory, the unit(s) indicated below is/are in accordance with the harmonised EU guidelines, EU standards of safety and product specific standards. This certificate becomes void if the unit(s) is/are modified without our approval.</p>	<p><b>CS EU prohlášení o shodě</b> Podpisáná osoba splnomocnená výrobcem GARDENA Germany AB, PO Box 7454, S-103 92, Stockholm, Švédsko potvrzuje, že v následujícím uvedený(-é) přístroj(-e) v provedení námi uvedeném na trh splňuje/splňuje požadavky směrnice EU, bezpečnostních norem EU a norem specifických pro výrobek. V případě změny přístroje(-ů), která s námi nebyla dohodnuta, ztrácí toto prohlášení svou platnost.</p>
<p><b>FR Déclaration de conformité CE</b> Le soussigné déclare, en tant que mandataire du fabricant, la GARDENA Germany AB, PO Box 7454, S-103 92, Stockholm, Suède, qu'à la sortie de ses usines le matériel neuf désigné ci-dessous était conforme aux prescriptions des directives européennes énoncées ci-après et conforme aux règles de sécurité et autres règles qui lui sont applicables dans le cadre de l'Union européenne. Toute modification portée sur ce(s) produit(s) sans l'accord express de notre part supprime la validité de ce certificat.</p>	<p><b>SK EÚ vyhlásenie o zhode</b> Dolú podpísaný potvrdzuje, ako splnomocnený zástupca výrobcu, GARDENA Germany AB, PO Box 7454, S-103 92, Stockholm, Švédsko, že ďalej označené zariadenie /a/ vo vyhotovení uvedenom na trh spĺňa /jú požiadavky harmonizovaných smerníc EU, bezpečnostných štandardov EU a predpisov, špecifických pre dané výrobky. Pri zmene zariadenia /zariadení, ktorá nebola odsúhlasená našou spoločnosťou, stráca toto vyhlásenie platnosť.</p>
<p><b>NL EU-conformiteitsverklaring</b> De ondergetekende bevestigt als gevolmachtigde van de fabrikant, GARDENA Germany AB, PO Box 7454, S-103 92, Stockholm, Zweden, dat het /de onderstaand vermelde apparaat/apparaten in de door ons in de handel gebrachte uitvoering voldoet/voldoen aan de eisen van de geharmoniseerde EU-richtlijnen, EU-veiligheidsnormen en productspecifieke normen. Bij een niet met ons afgestemde verandering van het apparaat/de apparaten verliest deze verklaring haar geldigheid.</p>	<p><b>EL Δήλωση συμμόρφωσης ΕΕ</b> Ο υπογεγραμμένος βεβαιώνει ως πληρεξούσιος του κατασκευαστή, της εταιρείας GARDENA Germany AB, T.Θ. 7454, S-103 92, Στοκχόλμη, Σουηδία, ότι η(οι) παρακάτω αναφερόμενη(ς) συσκευή(ς) στην έκδοσή που τίθεται από εμάς σε κυκλοφορία πληροί/πληρούν τις απαιτήσεις των ευρωπαϊκών οδηγιών της ΕΕ, προτύπων ασφαλείας της ΕΕ και των ειδικών για το προϊόν προτύπων. Σε περίπτωση τροποποίησης της (των) συσκευής(ών) χωρίς προηγούμενη συνεννόηση με την εταιρεία μας παύει να ισχύει η δήλωση.</p>
<p><b>SV EU-försäkran om överensstämmelse</b> Undertecknad intygar som befulldäktad företrädare för tillverkaren, GARDENA Germany AB, PO Box 7454, S-103 92, Stockholm, Sverige, att nedan angiven apparat/apparater i det utförande vi har släppt på marknaden, uppfyller förordningarna i de harmoniserade EU-direktiv, EU-säkerhetsstandarderna och de produktspecifika standarderna. Denna försäkran upphör att gälla vid en ändring av apparaten/apparaterna som inte har stämts av med oss.</p>	<p><b>SL Izjava EU o skladnosti</b> Spodaj podpisani kot pooblaščenec proizvajalca GARDENA Germany AB, PO Box 7454, S-103 92, Stockholm, Švedska, potrjuje, da v nadaljevanju označene naprave v izvedbi, v kakršni smo jih dali v promet, izpolnjuje zahteve usklajenih direktiv EU, varnostnega standarda EU in standardov, ki veljajo za posamezne izdelke. V primeru spremembe naprave, ki ni usklajena z nami, ta izjava neha veljati.</p>
<p><b>DA EU-overensstemmelseserklæring</b> Underskriveren bekræfter som fuldmægtig for producenten, GARDENA Germany AB, PO Box 7454, S-103 92, Stockholm, Sverige, at det (de) efterfølgende betegnede apparat(er) i den af os markedsførte udførelse opfylder kravene i de harmoniserede EU-direktiver, EU-sikkerhedsstandarder og produktspecifikke standarder. Foretages en ændring af apparatet/apparaterne, der ikke er aftalt med os, mister denne erklæring sin gyldighed.</p>	<p><b>HR EU izjava o sukladnosti</b> Dolje potpisani kao ovlaštenik proizvođača, tvrtke GARDENA Germany AB, PO Box 7454, S-103 92, Stockholm, Švedska, potvrđuje, da u nadaljevanju naznačene naprave u izvedbi, u kakršni smo ih dali u promet, izpunjavaju kriterije uskladenih direktiva EU i sigurnosnih standarda EU kao i standarda koji se tiču proizvoda. Ova izjava gubi valjanost u slučaju izmjena uređaja koje nisu prethodno ugovorene s nama.</p>
<p><b>FI EU-vaatimustenmukaisuusvakuutus</b> Allekirjoittanut vahvistaa valmistajan, GARDENA Germany AB, PO Box 7454, S-103 92, Tukholma, Ruotsi, valtuuttamansa henkilöä, että seuraava laite täyttää/ seuraavat laitteet täyttävät meidän toimittamassa mallissa yhdenmukaistettujen EU-direktiivien, EU-turvallisuusmääräysten ja tuotekohtaisien standardien vaatimukset. Laitteen/ laitteiden muutoksissa, joista ei ole sovittu meidän kanssamme, menettää tämä selvitys voimassolonsa.</p>	<p><b>RO Declarație de conformitate UE</b> Semnatarul, în calitate sa de împuternicit al producătorului GARDENA Germany AB, PO Box 7454, S-103 92, Stockholm, Suedia, confirmă că aparatul (aparatele) descrise în cele ce urmează, în execuția pusă de noi pe piață îndeplinesc cerințele directivelor armonizate UE, ale standardelor de siguranță UE și ale standardelor specifice produsului. În cazul modificării fără aprobarea noastră prealabilă a aparatului (aparatoarelor), această declarație își pierde valabilitatea.</p>
<p><b>IT Dichiarazione di conformità UE</b> Il sottoscritto, in quanto soggetto autorizzato dal produttore, GARDENA Germany AB, PO Box 7454, S-103 92, Stoccolma, Svezia, dichiara che l'apparecchio/gli apparecchi di seguito denominato/i, nella versione da noi immessa in commercio, soddisfa/no i requisiti delle direttive UE armonizzate, degli standard di sicurezza europei e degli standard specifici per il prodotto. La presente dichiarazione perde di validità in caso di modifica dell'apparecchio/degli apparecchi non concordata con noi.</p>	<p><b>BG ЕС-Декларация за съответствие</b> Долноподписаният удостоверява като пълномощник на производителя GARDENA Germany AB, PO Box 7454, S-103 92, Стокхолм, Швеция, че по-долу описания(ите) уред(и) във варианта на изпълнение пунат от нас на пазара изпълнява/ изпълняват изискванията на хармонизираните ЕС-директиви, ЕС-норми за безопасност и специфичните норми за продукцията. В случай на промяна на уред(ите), която не е съгласувана с нас, тази декларация губи своята валидност.</p>
<p><b>ES Declaración de conformidad de la UE</b> El firmante confirma, en calidad de apoderado del fabricante GARDENA Germany AB, PO Box 7454, S-103 92 Estocolmo (Suecia), que el/ los aparato(s) mencionado(s) a continuación cumple(n), en la versión lanzada al mercado por nuestra empresa, los requisitos de las directivas de la UE armonizadas, los estándares de seguridad de la UE y los estándares específicos del producto. La presente declaración perderá su validez si se modifica(n) el/ los aparato(s) sin previa aprobación por nuestra parte.</p>	<p><b>ET EL-i vastavusdeklaratsioon</b> Allakirjutatu kinnitab tootja, GARDENA Germany AB, PO Box 7454, S-103 92, Stockholm, Rootsi, poolt volitatud isikuna, et järgnevalt nimetatud seade (seadmed) täidab (täidavad) meid poolt turule toodud versiooni kuul harmoniseeritud EL-i direktiivide, EL-i ohutusstandardide ja tootepõhiste standardite nõudeid. Seadme (seadmete) meiega kooskõlastamata muudatuste tegemise korral kaotab käesolev deklaratsioon oma kehtivuse.</p>
<p><b>PT Declaração CE de Conformidade</b> O abaixo-assinado, na qualidade de representante do fabricante, GARDENA Germany AB, PO Box 7454, S-103 92, Stockholm, Schweden, confirma que o(s) aparelho(s) a seguir designado(s) no modelo lançado por nós no mercado cumpre/ cumprem os requisitos das diretivas UE harmonizadas, as normas de segurança UE e as normas específicas para estes produtos. Esta declaração perde a sua validade se forem realizadas alterações no(s) aparelho(s) sem o nosso consentimento.</p>	<p><b>LT ES atitikties deklaracija</b> Pasirašantis, kaip gamintojo, GARDENA Germany AB, PO Box 7454, S-103 92, Stokholmas, Švedija, įgaliotasis atstovas patvirtina, kad žemiau nurodyti(-ų) prietais(-ų) modeliai, kurie buvo pagaminti mūsų gamykloje, atitinka darniasias ES direktyvas, ES saugumo standartus ir specifinius gaminių standartus. Atlikus bet koki prietais(-ų) pakeitimą, kuris nėra suderintas su mumis, ši deklaracija praranda galiojimą.</p>
<p><b>PL Deklaracja zgodności UE</b> Nижєj podpisany potwierdza jako upoważniony przedstawiciel producenta, spółki GARDENA Germany AB, PO Box 7454, S-103 92, Stokholm, Szwecja, że określone poniżej urządzenie/-nia w wersji wprowadzonej przez nas do obrotu spełnia/ -niają wymogi zharmonizowanych dyrektyw UE, norm bezpieczeństwa UE oraz norm dotyczących konkretnych produktów. Niniejsza deklaracja traci ważność w przypadku wprowadzania niezgodnych z nami zmian urządzenia/-n.</p>	<p><b>LV ES atbilstības deklarācija</b> Lēm parakstījis šīs personas kā ražotāja, GARDENA Germany AB, PO Box 7454, S-103 92, Stokholma, Zviedrija, pilnvarotais pārstāvis apstiprina, ka tālāk norādītā(-s) ierīcē(-s) izpildījuma, kādā mēs to (tās) esam laidīši tirgū, atbilst skaidrotajām ES direktīvam, ES drošības standartiem un konkrētiem produktām noteiktiem standartiem. Ierīcē(-s) veicot ar mums nesaskaņotas izmaiņas, šī deklarācija zaudē savu spēku.</p>

<p>Produktbezeichnung: Description of the product: Désignation du produit : Beschrijving van het product: Beskrivning av produkten: Beskrivelse af produktet: Tuotteen kuvaus: Descrizione del prodotto: Descripción del producto: Descrição do produto: Opis produktu: A termék leírása: Popis výrobku: Popis produktu: Περιγραφή του προϊόντος: Opis izdelka: Opis proizvoda: Descrierea produsului: Описание на продукта: Toote kirjeldus: Gaminio aprašas: Izstrādājuma apraksts:</p>	<p><b>Akku-Teleskop-Heckenschere</b> <b>Telescopic Battery Hedge Trimmer</b> <b>Taille-haies télescopique sur accu</b> <b>Telescopische accu-heggenschaar</b> <b>Accu Teleskophacksax</b> <b>Akku-teleskop-hækkeklipper</b> <b>Teleskoopivarrellinen akkupensasleikkuri</b> <b>Tagliat siepi telescopica a batteria</b> <b>Recortasetos telescópico con Accu</b> <b>Corta-sebes telescópico accu</b> <b>Akkumulátorowe nożyce do żywopłotu z trzonkiem teleskopowym</b> <b>Akkumulátoros-teleszkópos sövénynyíró</b> <b>Akkumulátorové teleskopické nožky na živý plot</b> <b>Akkumulátorové nožnice na živý plot</b> <b>Τηλεσκοπικό μηχανοτροφοϋλάδιο μπαταρίας</b> <b>Akkumulatorske teleskopske škarje za živo mejo</b> <b>Teleskopske škare za živicu s akkumulátorom</b> <b>Trimmer telescopic cu acumulator pentru gard viu</b> <b>Akkumulatorna teleskopična nožnica za živ plot</b> <b>Aku ja teleskoopvarrega hekiääriid</b> <b>Akkumulatörinés teleskopinés gyvatvoriu žirkles</b> <b>Teleskopiskās dzīvzogu šķēres ar akkumulātoru</b></p>	<p>Harmonisierte EN-Normen / Harmonised EN: <b>EN ISO 12100</b> <b>EN 62841-1</b> <b>EN 62841-4-2</b></p> <p>Ladegerät/ Charger: <b>EN 60335-2-29</b></p> <p>Schall-Leistungspegel: Noise level: Niveau sonore : Geluksniveaue: Ljudnivå: Støjniveau: Äänitaso: Livello acustico: Nivel de ruido: Poziom hałas: Zašjzint: Hladina hluku:</p> <p>gemessen/ garantiert measured/ guaranteed mesure/ garanti gemeten/ gegarandeerd määritetty/ garantoid mält/ garanteret mittattu/ taattu misurato/ garantito medido/ garantizado medido/ garantido zmierzony/ gwarantowany mért/ garantált määrénen/ zaručená</p> <p>Hladiny hluku: Επίπεδο θορύβου: Raven zvočne moči: Razina buke: Nível de zgomot: Ниво на шум: Mūratase: Triukšmo lygis: Trokšņa līmenis :</p> <p>nameranē/zaručené μετρημένο/ εγγυημένο izmerjena/ zagotovljena mjerena/ zajamčena māsurat/ garantāta измерено/ гарантирано mērotētu/ garantērtutu išmērotas/ garantuojamas mērtas/ garantētais</p> <p>Anbringungsjahr der CE-Kennzeichnung: Year of CE marking: Année d'apposition du marquage CE : Installatiejaar van de CE-aanduiding: Märkningsår: CE-Mærkningsår: CE-merkin kiinnitysvuosi: Anno di applicazione della certificazione CE: Colocación del distintivo CE: Ano de marcação pela CE: Rok nadania oznakowania CE:</p> <p>CE-jelzésé elhelyezésének éve: Rok umístění značky CE: Rok udelenia značky CE: Έτος οµήρατος CE: Leto namestitve CE-oznake: Godina dobivanja CE oznake: Anul de marcare CE: Година на поставяне на CE-маркировка: CE-mārgistuse paigaldamise aasta: Metai, kada pažymėta CE-ženklui: CE-markejuma uzlikšanas gads:</p> <p><b>2020</b></p> <p>Ulm, den 30.10.2020 Ulm, 30.10.2020 Fait à Ulm, le 30.10.2020 Ulm, 30-10-2020 Ulm, 2020.10.30. Ulm, 30.10.2020 Ulm, 30.10.2020 Ulm, 30.10.2020 Ulm, 30.10.2020 Ulm, 30.10.2020 Ulm, 30.10.2020 Ulm, 30.10.2020 Ulm, 30.10.2020 Ulm, 30.10.2020 Ulm, 30.10.2020 Ulm, 30.10.2020 Ulm, 30.10.2020 Ulm, 30.10.2020 Ulm, 30.10.2020 Ulm, 30.10.2020</p> <p>Der Bevollmächtigte Authorised representative Le mandataire De gevolmachtigde Auktoriserad representant Autoriseret repræsntant Valtuutettu edustaja Persona delegata La persona autorizada O representante Pelnomocnik Meghatalmazott Splnomocnenec Splnomocnený Ο εξουσιοδοτημένος Pooblaščenec Ovlaštena osoba Conducerea tehnică Упълномощен Volitatud esindaja Igalotiasis atstovas Pilnvarotā persona</p> <p><i>Reinhard Pompe</i> <b>Reinhard Pompe</b> Vice President</p>
<p><b>THS 42/18V P4A</b></p> <p>EU-Richtlijnen: EC-Directives: Directives CE : EG-richtlijnen: EU-direktiv: EF-direktiver: EY-direktiivit: Direttive UE: Directiva CE: Diretivas CE: Dyrektywy WE: EK-irányelvek: Predpisy ES: Smernice EÚ: Οδηγίες EK: Direktive EU: EC direktive: Directive CE: Директиви на EO: EU direktiivid:</p>	<p>Terméktípus: Druh výrobku: Type de produit: Producttype: Producttype: Producttype: Tuotetyypit: Tipo adi prodotto: Tipo de producto: Tipo de produto: Typ produktu:</p> <p>EB direktivos: EK direktivas:</p> <p>Artikelnnummer: Article number: Réfarence : Artikelnnummer: Artikelnnummer: Tuotenumero: Codice articolo: Referencia: Número de referència: Numer katalogowy:</p> <p>Cikkszámok: Objednací číslo: Objednávacie číslo: Κωδικός είδους: Številka izdelka: Kataloški broj: Cod article: Artikulin nimer: Artikelnnummer: Dahies numeris: Artikula numurs:</p> <p>Deposited Documentation: GARDENA Technical Documentation, M. Kugler 89079 Ulm</p> <p>Conformity Assessment Procedure: according to 2000/14/EC Art.14 Annex V</p> <p>Documentation déposée : Documentation technique GARDENA, M. Kugler 89079 Ulm</p> <p>Procédure d'évaluation de la conformité : Selon 2000/14/CE art. 14 Annexe V</p>	<p>2000/14/EG 2006/42/EG 2011/65/EU 2014/30/EU</p> <p>Ladegerät/ Charger: <b>2014/35/EC</b></p>

**Deutschland / Germany**

GARDENA  
Manufacturing GmbH  
Central Service  
Hans-Lorenser-Straße 40  
D-89079 Ulm  
Produktfragen:  
(+49) 731 490-123  
Reparaturen:  
(+49) 731 490-290  
service@gardena.com  
http://www.gardena.com

**Albania**

KRAFT SHPK  
Autostrada Tirane-Durres  
Km 7  
1051 Tirane

**Argentina**

ROBERTO C. RUMBO S.R.L.  
Predio Norlog  
Lote 7  
Benavidez. ZC:1621  
Buenos Aires  
ventas@rubmosrl.com.ar

**Australia**

Husqvarna Australia Pty. Ltd.  
Locked Bag 5  
Central Coast BC  
NSW 2252  
Phone: (+61) (0) 2 4352 7400  
customer.service@  
husqvarna.com.au

**Austria / Österreich**

Husqvarna Austria GmbH  
Industriezeile 36  
4010 Linz  
Tel.: (+43) 732 77 01 01-485  
service.gardena@  
husqvarnagroup.com

**Azerbaijan**

Firm Progress  
a. Aliyev Str. 26A  
1052 Baku

**Belarus**

Private Enterprise  
"Master Garden"  
Minsk  
Sharangovich str., 7a  
Phone: (+375) 17 257-00-33  
Mob.: (+375) 29 676-16-09  
mg@mastergarden.by

**Belgium**

Husqvarna Belgium nv  
Gardena Division  
Leuvensesteenweg 542  
Planet II E  
1930 Zaventem  
België

**Bosnia / Herzegovina**

SILK TRADE d.o.o.  
Industrijska zona Bukva bb  
74260 Tešanj

**Brazil**

Husqvarna do Brasil Ltda  
Av. Francisco Matarazzo,  
1400 - 19º andar  
São Paulo - SP  
CEP: 05001-903  
Tel: 0800-112252  
marketing.br.husqvarna@  
husqvarna.com.br

**Bulgaria**

AGROLAND България АД  
бул. 8 Декември, №13  
Офис 5  
1700 Студентски град  
София  
Тел.: (+359) 2466 69 10  
info@agroland.eu

**Canada / USA**

GARDENA Canada Ltd.  
100 Summerlea Road  
Brampton, Ontario L6T 4X3  
Phone: (+1) 905 792 93 30  
info@gardenacanada.com

**Chile**

REPRESENTACIONES  
JCE S.A.  
Av. Del Valle Norte 857,  
Piso 4  
Santiago RM  
Phone: (+56) 2 24142560  
contacto@jce.cl

**China**

Husqvarna (Shanghai)  
Management Co., Ltd.  
富世华 (上海) 管理有限公司  
3F, Benq Square B,  
No207, Song Hong Rd.,  
Chang Ning District,  
Shanghai  
PRC. 200335  
上海市长宁区淞虹路207号明  
基广场B座3楼, 邮编: 200335

**Colombia**

Husqvarna Colombia S.A.  
Calle 18 No. 68 D-31, zona  
Industrial de Montevideo  
Bogotá, Cundinamarca  
Tel. 571 2922700 ext. 105  
jairo.salazar@  
husqvarna.com.co

**Costa Rica**

Compania Exim  
Euroiberoamericana S.A.  
Los Colegios, Moravia,  
200 metros al Sur del Colegio  
Saint Francis - San José  
Phone: (+506) 297 68 83  
exim\_euro@racsa.co.cr

**Croatia**

Husqvarna Austria GmbH  
Industriezeile 36  
4010 Linz  
Tel.: (+43) 732 77 01 01-485  
service.gardena@  
husqvarnagroup.com

**Cyprus**

Med Marketing  
17 Digeni Akrita Ave  
P.O. Box 27017  
1641 Nicosia

**Czech Republic**

Husqvarna Česko s.r.o.  
Türkova 2319/5b  
149 00 Praha 4 - Chodov  
Bezplatná infolinka:  
800 100 425  
servis@cz.husqvarna.com

**Denmark**

GARDENA DANMARK  
Lejrvvej 19, st.  
3500 Værløse  
Tlf.: (+45) 7026 4770  
husqvarna@husqvarna.dk  
www.gardena.com/dk

**Dominican Republic**

BOSQUESA, S.R.L  
Carretera Santiago Licey  
Km. 5 ½  
Esquina Copal II.  
Santiago  
Dominican Republic  
Phone: (+809) 736-0333  
joserbosquesa@claro.net.do

**Ecuador**

Husqvarna Ecuador S.A.  
Arupos E1-181 y 10 de  
Agosto Quito, Pichincha  
Tel. (+593) 22800739  
francisco.jacome@  
husqvarna.com.ec

**Estonia**

Husqvarna Eesti OÜ  
Valdeku 132  
EE-11216 Tallinn  
info@agardena.ee

**Finland**

Oy Husqvarna Ab  
Gardena Division  
Lautatarhankatu 8 B/PL 3  
00581 HELSINKI  
www.gardena.fi

**France**

Husqvarna France  
9/11 Allée des pierres mayettes  
92635 Gennevilliers Cedex  
France  
http://www.gardena.com/fr  
N° AZUR: 0 810 00 78 23  
(Prix d'un appel local)

**Georgia**

Transporter LLC  
113b Beliashvili street  
0159 Tbilisi, Georgia

**Great Britain**

Husqvarna UK Ltd  
Preston Road  
Aycliffe Industrial Park  
Newton Aycliffe  
County Durham  
DL5 6UP  
info.gardena@  
husqvarna.co.uk

**Greece**

Π. ΠΑΠΑΔΟΠΟΥΛΟΣ ΑΕΒΕ  
Λεωφ. Αθηνών 92  
Αθήνα  
T.K.104 42  
Ελλάδα  
Τηλ. (+30) 210 51 93 100  
info@papadopoulos.com.gr

**Hungary**

Husqvarna Magyarország Kft.  
Ezred u. 1-3  
1044 Budapest  
Telefon: (+36) 1 251-4161  
vevoszolgalat.husqvarna@  
husqvarna.hu

**Iceland**

BYKO ehf.  
Bildshöfoa 20  
110 Reykjavik

**Ireland**

Husqvarna UK Ltd  
Preston Road  
Aycliffe Industrial Park  
Newton Aycliffe  
County Durham  
DL5 6UP  
info.gardena@  
husqvarna.co.uk

**Italy**

Husqvarna Italia S.p.A.  
Via Santa Vecchia 15  
23868 VALMADRERA (LC)  
Phone: (+39) 0341.203.111  
assistenza.italia@  
it.husqvarna.com

**Japan**

Husqvarna Zenoah Co., Ltd.  
1-9 Minamidai  
Kawagoe  
350-1165 Saitama  
gardena-jp@  
husqvarnagroup.com

**Kazakhstan**

LAMED Ltd.  
155/1, Tazhibayevoy Str.  
050060 Almaty  
IP Schmidt  
Abayavenue 3B  
110 005 Kostanay

**Korea**

Kyung Jin Trading CO.,LTD.  
107-4, SunDuk Bld.,  
YangJae-dong,  
Seocho-gu,  
Seoul, (zipcode: 137-891)  
Phone: (+82) (0)2 574-6300

**Latvia**

Husqvarna Latvija SIA  
Ulbrokas 19A  
LV-1021 Riga  
info@gardena.lv

**Lithuania**

UAB Husqvarna Lietuva  
Ateities pl. 77C  
LT-52104 Kaunas  
info@gardena.lt

**Luxembourg**

Magasins Jules Neuberg  
39, rue Jacques Stas  
Luxembourg-Gasperich 2549  
Case Postale No. 12  
Luxembourg 2010  
Phone: (+352) 40 14 01  
api@neuberg.lu

**Mexico**

AFOSA  
Av. Lopez Mateos Sur # 5019  
Col. La Calma 45070  
Zapopan, Jalisco  
Mexico  
Phone: (+52) 33 3818-3434  
icornejo@afosa.com.mx

**Moldova**

Convel S.R.L.  
290A Muncesti Str.  
2002 Chisinau

**Netherlands**

Husqvarna Nederland B.V.  
GARDENA Division  
Postbus 50131  
1305 AC ALMERE  
Phone: (+31) 36 521 00 10  
info@gardena.nl

**Neth. Antilles**

Jonka Enterprises N.V.  
Sta. Rosa Weg 196  
P.O. Box 8200  
Curaçao  
Phone: (+599) 9 767 66 55  
pgm@jonka.com

**New Zealand**

Husqvarna New Zealand Ltd.  
PO Box 76-437  
Manukau City 2241  
Phone: (+64) (0) 9 9202410  
support.nz@husqvarna.co.nz

**Norway**

Husqvarna Norge AS  
Gardena Division  
Trøskenvæien 36  
1708 Sarpsborg  
info@gardena.no

**Peru**

Husqvarna Perú S.A.  
Jr. Ramón Cárcamo 710  
Lima 1  
Tel: (+51) 1 3320 400 ext. 416  
juan.remuzgo@  
husqvarna.com

**Poland**

Husqvarna  
Poland Spółka z o.o.  
ul. Wysockiego 15 b  
03-371 Warszawa  
Phone: (+48) 22 330 96 00  
gardena@husqvarna.com.pl

**Portugal**

Husqvarna Portugal, SA  
Lagoa - Albarraque  
2635 - 595 Rio de Mouro  
Tel.: (+351) 21 922 85 30  
Fax : (+351) 21 922 85 36  
info@gardena.pt

**Romania**

Madex International Srl  
Soseaua Odaii 117-123,  
RO 013603 București, S1  
Phone: (+40) 21 352.76.03  
madex@ines.ro

**Russia / Россия**

ООО „Хускварна“  
141400, Московская обл.,  
г. Химки,  
улица Ленинградская,  
владение 39, стр.6  
Бизнес Центр  
„Химки Бизнес Парк“,  
помещение ОВ02\_04  
http://www.gardena.ru

**Serbia**

Domel d.o.o.  
Autoput za Novi Sad bb  
11273 Belgrade  
Phone: (+381) 1 18 48 88 12  
miroslav.jejina@domel.rs

**Singapore**

Hy-Ray PRIVATE LIMITED  
40 Jalan Pemimpin  
#02-08 Tat Ann Building  
Singapore 577185  
Phone: (+65) 6253 2277  
shiyong@hyray.com.sg

**Slovak Republic**

Husqvarna Česko s.r.o.  
Türkova 2319/5b  
149 00 Praha 4 - Chodov  
Bezplatná infolinka: 800 154 044  
servis@sk.husqvarna.com

**Slovenia**

Husqvarna Austria GmbH  
Industriezeile 36  
4010 Linz  
Tel.: (+43) 732 77 01 01-485  
service.gardena@  
husqvarnagroup.com

**South Africa**

Husqvarna South Africa (Pty) Ltd  
Postnet Suite 250  
Private Bag X6,  
Cascades, 3202, South Africa  
Phone: (+27) 33 846 9700  
info@gardena.co.za

**Spain**

Husqvarna España S.A.  
Calle de Rivas nº 10  
28052 Madrid  
Phone: (+34) 91 708 05 00  
atencioncliente@gardena.es

**Suriname**

Deto Handelmaatschappij N.V.  
Kernkampweg 72-74  
P.O.Box: 12782  
Paramaribo - Suriname  
South America  
Phone: (+597) 438050  
www.deto.sr

**Sweden**

Husqvarna AB/  
GARDENA Sverige  
Drottninggatan 2  
561 82 Huskvarna Sverige

**Switzerland / Schweiz**

Husqvarna Schweiz AG  
Consumer Products  
Industriestrasse 10  
5506 Mägenwil  
Phone: (+41) (0) 62 887 37 90  
info@gardena.ch

**Turkey**

Dost Bahçe Diş Ticaret  
Mümessillik A.Ş  
Yunus Mah. Adil Sok. No:3  
Ic Kapi No: 1 Kartal  
34873 Istanbul  
Phone: (+90) 216 38 93 939  
info@dostbahce.com.tr

**Ukraine / Україна**

ТОВ «Хускварна Україна»  
вул. Васильківська, 34,  
офіс 204-г  
03022, м. Київ  
Тел. (+38) 0 800 504 804  
info@gardena.ua

**Uruguay**

FELI SA  
Entre Ríos 1083 CP 11800  
Montevideo - Uruguay  
Tel: (+598) 22 03 18 44  
info@felisa.com.uy

**Venezuela**

Corporación Casa y Jardín C.A.  
Av. Caroní, Edif. Trezmen, PB.  
Colinas de Bello Monte.  
1050 Caracas.  
Tlf: (+58) 212 992 33 22  
info@casayjardin.net.ve

14732-20.960.01/0920  
© GARDENA Manufacturing GmbH  
D-89079 Ulm  
http://www.gardena.com