

4G+ LTE Dual Band Router 1200

Share your 4G+ LTE Internet connection in any place with any device!

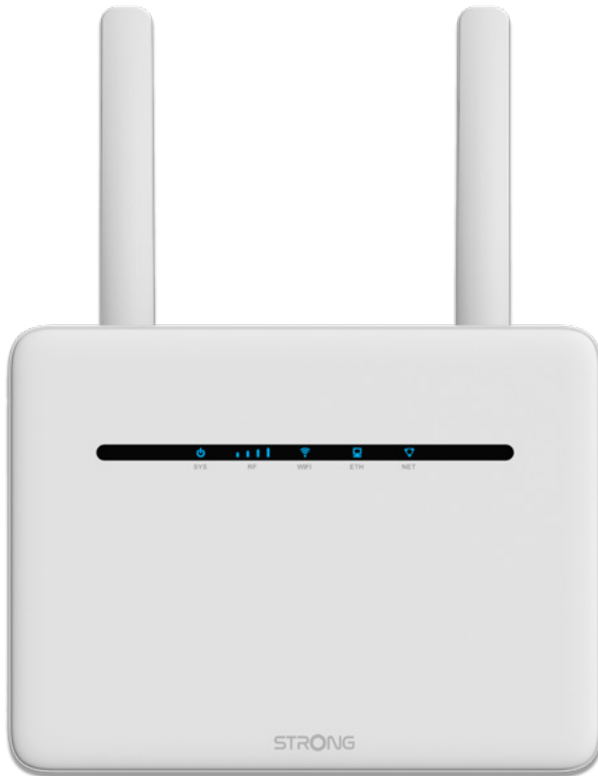

Do you have a low-speed Internet connection at home? Or do you need a second one for specific usages? Do you need a high-speed Internet connection in your secondary house or in your van?

Then our 4G+ LTE Router 1200 is exactly what you need!

Just insert a SIM card from any operator and immediately enjoy your Internet connection at speeds up to 300 Mbit/s. Speed and coverage depend on the operator and its service network. No configuration required, no mandatory subscription. Select any operator of your choice.

Share your high-speed Internet connection with any Wi-Fi device at speeds up to 1200 Mbit/s and connect any wired devices such as computer, Smart TV, game console or set-top-box to the Internet through one of 4 Gigabit Ethernet ports.

The product includes 2x external detachable antennas for an improved 4G+ LTE performance and also 2 SIM card adapters to fit with any size of SIM cards.

4G+ LTE Performance



- Speed up to 300 Mbit/s
- Works with any SIM card from any operator

Wi-Fi Performance



- Speed up to 300 Mbit/s
- IEEE 802.11 ac/n/b/g
- 300 Mbit/s @ 2.4 GHz + 867 Mbit/s@5GHz

Coverage & Reliability



- 2x detachable external 4G+ LTE antennas and 2x internal Wi-Fi antennas for maximum coverage and reliability
- Connect & Secure (WPS) button for an easy setup

Security



- Full PIN code management for the 4G+ LTE connection
- Works with any size of SIM card
- WPA/WPA2™ for the highest level of Wi-Fi security
- Connect & Secure (WPS) button for an optimum network security
- Wi-Fi On/Off button

Connections



- 4x Gigabit Ethernet LAN ports to connect any wired device
- 2x SIM card adapters to fit with any size of SIM card

4G+ LTE Dual Band Router 1200

Wireless

LTE Category	Cat 6
Network Type	LTE-FDD: B1/B3/B5/B7/B8/B20/B28/B32 LTE-TDD: B38/B40/B41
Wi-Fi Standards	IEEE 802.11b/g/n (2.4 GHz) IEEE 802.11 ac (5 GHz)
Signal Rate	300 Mbit/s at 2.4 GHz GHz + 867 Mbit/s@5GHz
Transmit Power	CE: <20 dBm @ 2.4 GHz CE: <23 dBm @ 5 GHz
Wi-Fi Functions	Enable/Disable Wireless Radio, WMM, Wireless Statistics
Wi-Fi Security	OPEN, WPA-PSK (TKIP), WPA-PSK (AES), WPA2-PSK (TKIP), WPA2-PSK (AES)
Wi-Fi SSID	4 concurrent
Wi-Fi MAC Filter	Yes
Antenna Type	2 Internal Wi-Fi Antennas 2 Detachable External 4G+ LTE Antennas

Hardware

Ethernet Ports	4x 10/100/ 1000 Mbps LAN port (Auto MDI/MDIX)
Buttons	WPS, Reset, Wi-Fi On/Off, Power On/Off
LEDs	Power, Internet, Wi-Fi, Connect & Secure (WPS), Mobile Network Signal Level
Power	External power supply, 12 V / 2 A DC
Standards	IEEE 802.11ac/n/g/b, IEEE 802.3, IEEE 802.3u

Software

Internet Protocol	IPv4/IPv6 Dual stack
Operation Modes	3G/4G Router, Wireless Router
DHCP	Server, Client
Port Forwarding	Yes
SIP ALG	Yes
Dynamic DNS	Dyndns, No-ip
Firewall Security	Port Filtering, Port Mapping, Port Forwarding, URL Filtering, DMZ, Rate Limiting
Management	Data Plan Management, Data Usage Statistics, Web UI Access, Ping & Trace Network Tools, Config Backup

Other specifications

Certification	CE
Package Contents	1x STRONG 4G+ LTE Router 1200 1x RJ45 Ethernet Cable 1x External Power Supply 2x Detachable External 4G+ LTE Antennas 1x Quick Installation Guide 1x Micro to Standard SIM Card Adapter 1x Nano to Standard SIM Card Adapter
System Requirements	Windows 7, 8, 8.1, 10, Mac OS X, Linux, Internet Browser

Environment

Operating Temperature:	0° ~ +40°
Storage Temperature:	-20° ~ +70°
Operating Humidity:	95% non-condensing
Storage Humidity:	95% non-condensing
Dimensions in mm:	180 x 132 x 48 (W x D x H)
Weight in kg:	0.29

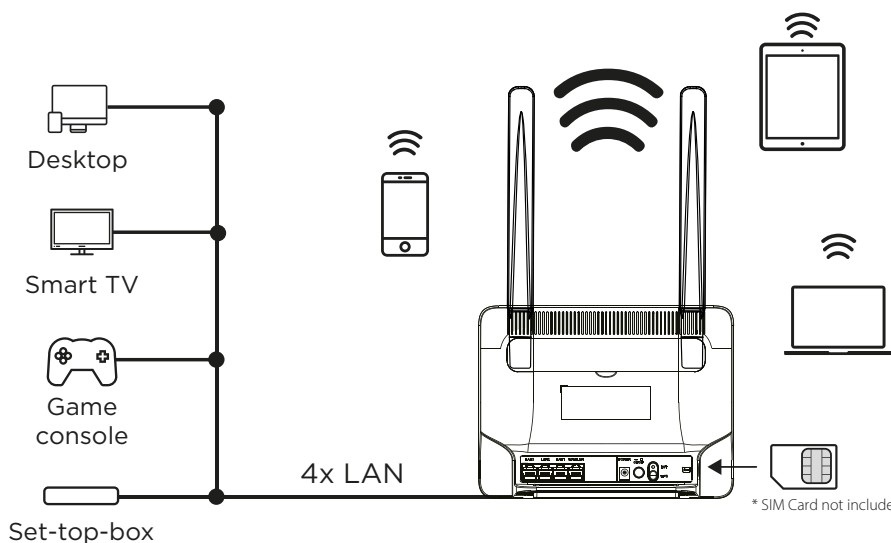

EAN: 9120072372599
PCB : 5 pcs