

---



---

## SURFACE CIRCULAR

---



---



---

## SURFACE CIRCULAR SENSOR

---

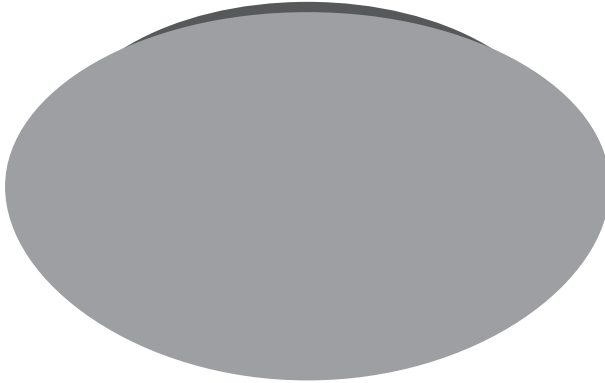

	EAN	Ø x h [mm]	W	V <sub>AC</sub>	Hz	lm	lm/W	K
SF CIRC 250 SEN V 13W 830 IP44	4058075617902	250x91	13	220-240	50/60	920	70	3000
SF CIRC 250 SEN V 13W 840 IP44	4058075617926	250x91	13	220-240	50/60	960	75	4000
SF CIRC 250 V 13W 830 IP44	4058075617865	250x91	13	220-240	50/60	920	70	3000
SF CIRC 250 V 13W 840 IP44	4058075617889	250x91	13	220-240	50/60	960	75	4000
SF CIRC 350 SEN V 18W 830 IP44	4058075617988	350x115	18	220-240	50/60	1440	80	3000
SF CIRC 350 SEN V 18W 840 IP44	4058075618008	350x115	18	220-240	50/60	1440	80	4000
SF CIRC 350 V 18W 830 IP44	4058075617940	350x115	18	220-240	50/60	1440	80	3000
SF CIRC 350 V 18W 840 IP44	4058075617964	350x115	18	220-240	50/60	1440	80	4000
SF CIRC 400 SEN V 24W 830 IP44	4058075618084	400x120	24	220-240	50/60	1920	80	3000
SF CIRC 400 SEN V 24W 840 IP44	4058075618121	400x120	24	220-240	50/60	1920	80	4000
SF CIRC 400 V 24W 830 IP44	4058075618022	400x120	24	220-240	50/60	1920	80	3000
SF CIRC 400 V 24W 840 IP44	4058075618046	400x120	24	220-240	50/60	1920	80	4000

	EAN	IP	IK	∠	R <sub>a</sub>	ΔT (°C)	PF	👤
SF CIRC 250 SEN V 13W 830 IP44	4058075617902	44	03	120°	> 80	-20...+40	> 0.5	0.4 kg
SF CIRC 250 SEN V 13W 840 IP44	4058075617926	44	03	120°	> 80	-20...+40	> 0.5	0.4 kg
SF CIRC 250 V 13W 830 IP44	4058075617865	44	03	120°	> 80	-20...+40	> 0.5	0.4 kg
SF CIRC 250 V 13W 840 IP44	4058075617889	44	03	120°	> 80	-20...+40	> 0.5	0.4 kg
SF CIRC 350 SEN V 18W 830 IP44	4058075617988	44	03	120°	> 80	-20...+40	> 0.5	0.6 kg
SF CIRC 350 SEN V 18W 840 IP44	4058075618008	44	03	120°	> 80	-20...+40	> 0.5	0.6 kg
SF CIRC 350 V 18W 830 IP44	4058075617940	44	03	120°	> 80	-20...+40	> 0.5	0.6 kg
SF CIRC 350 V 18W 840 IP44	4058075617964	44	03	120°	> 80	-20...+40	> 0.5	0.6 kg
SF CIRC 400 SEN V 24W 830 IP44	4058075618084	44	03	120°	> 80	-20...+40	> 0.5	0.8 kg
SF CIRC 400 SEN V 24W 840 IP44	4058075618121	44	03	120°	> 80	-20...+40	> 0.5	0.8 kg
SF CIRC 400 V 24W 830 IP44	4058075618022	44	03	120°	> 80	-20...+40	> 0.5	0.8 kg
SF CIRC 400 V 24W 840 IP44	4058075618046	44	03	120°	> 80	-20...+40	> 0.5	0.8 kg

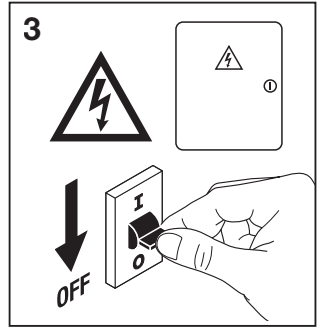
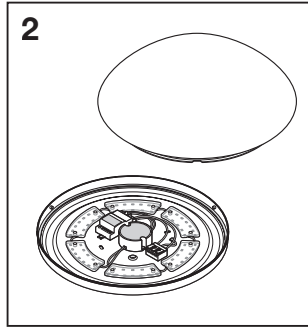
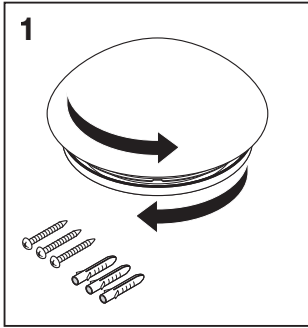

### IP44

4

[mm]	d
SURFACE CIRCULAR 250	157
SURFACE CIRCULAR 350	223
SURFACE CIRCULAR 400	266

### IP20

4

[mm]	s
SURFACE CIRCULAR 250	110
SURFACE CIRCULAR 350	95
SURFACE CIRCULAR 400	130

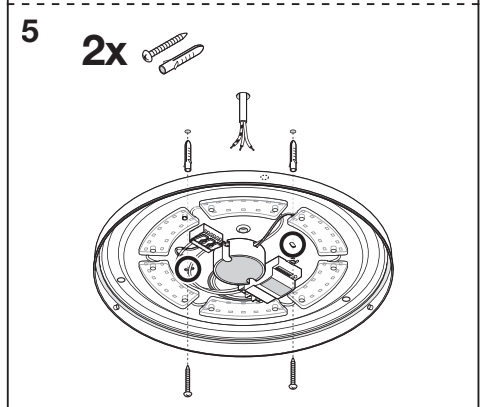
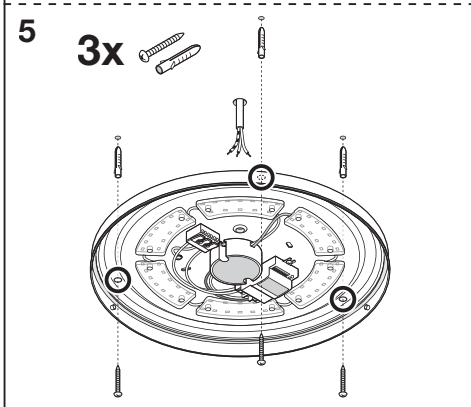

6

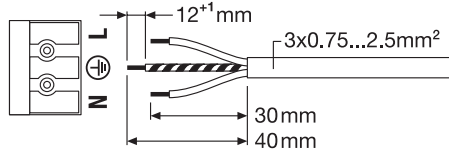
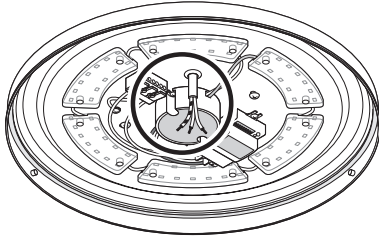

7: SURFACE CIRCULAR SENSOR

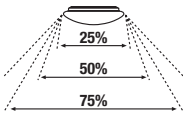
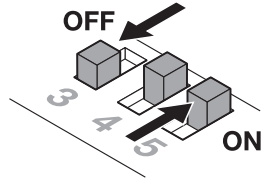
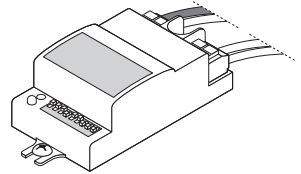
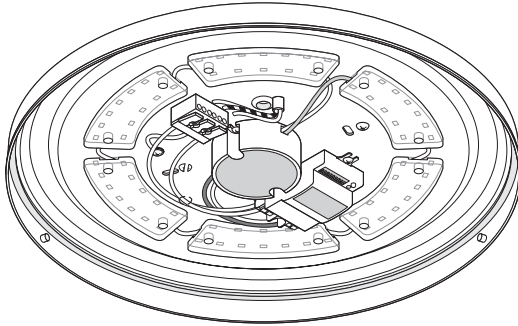

Detection Area

1	2	3	
ON	ON	ON	100 %
-	ON	ON	75 %
ON	-	ON	50 %
-	-	ON	25 %
-	-	-	10 %



Hold Time

4	5	6	
ON	ON	ON	5 s
-	ON	ON	30 s
ON	-	ON	90 s
-	-	ON	3 min
ON	ON	-	20 min
-	-	-	30 min







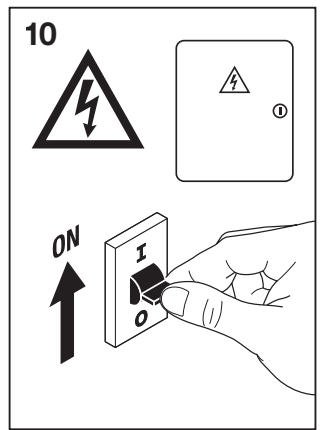
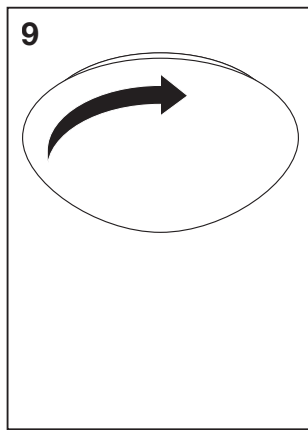
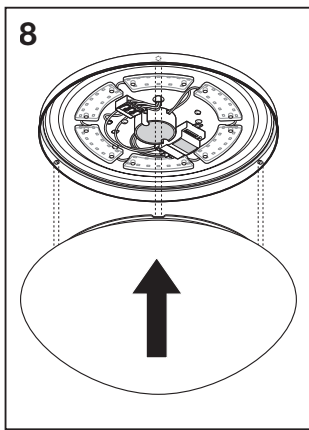
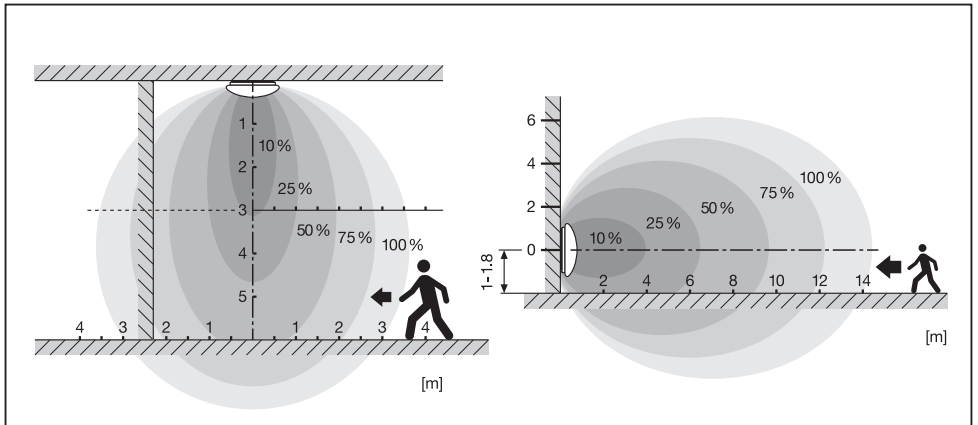





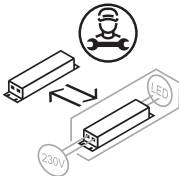

Daylight Sensor

7	8	9	
ON	ON	ON	2 LUX
ON	ON	-	10 LUX
-	ON	-	25 LUX
ON	-	-	50 LUX
-	-	-	Disable



	EAN	Ø x h [mm]
SF CIRCULAR 250 COVER	4058075156722	250x80
SF CIRCULAR 350 COVER	4058075156807	350x104
SF CIRCULAR 400 COVER	4058075156821	400x112

C10449057  
 G11121226  
 17.05.21

**LEDVANCE GmbH**  
 Steinerne Furt 62  
 86167 Augsburg, Germany  
[www.ledvance.com](http://www.ledvance.com)