

LED

24VDC LED PS 6W

DVT LIGHT

Powered by Develtron

SNAPPY STRØMFORSYNING / POWER SUPPLY

Specifikationer

Varenr.:	VN600240
Udgangsspænding	24VDC
Udgangseffekt	6W
Udgangsstrøm:	0-0.25A
Indgangsspænding	180-264Vac
Input frekvens	50/60Hz
Omgivelsestemperatur	-20°C ~ 45°C
Arbejdsfugtighed	45% ~ 85%
Tætningklasse	IP20
Beskyttelsesklasse	Class II
Levetid / timer:	30.000
Dimensioner L x B x H	98,4 x 45,6 x 10,7 mm



PRODUCT SPECIFICATION / DVT LIGHT / DEVELTRON



Dimensioner:



Foto:



LED

DVT LIGHT

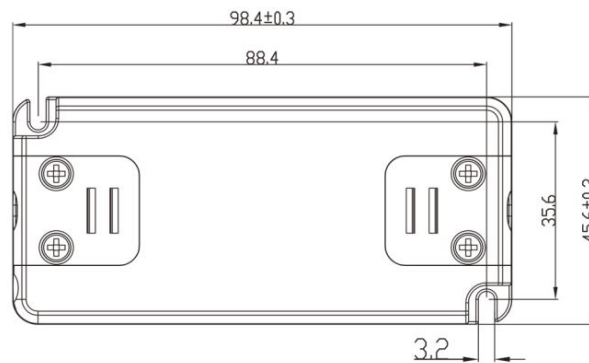
Powered by Develtron

24VDC LED PS 6W

SNAPPY STRØMFORSYNING / POWER SUPPLY

Specifications:

Item no.:	VN600240
Output Voltage:	24VDC
Output Power:	6W
Output Current:	0-0.25A
Input Voltage:	180-264VAC
Input Frequency:	50/60Hz
Working temperature:	-20°C ~ 45°C
Working Humidity:	45% ~ 85%
IP Protection Class:	IP20
Appliance Class:	Class II
Life Cycle - Hours:	30.000
Dimensions L x W x H:	98,4 x 45,6 x 10,7 mm



PRODUCT SPECIFICATION / DVT LIGHT / DEVELTRON

Dimensioner:

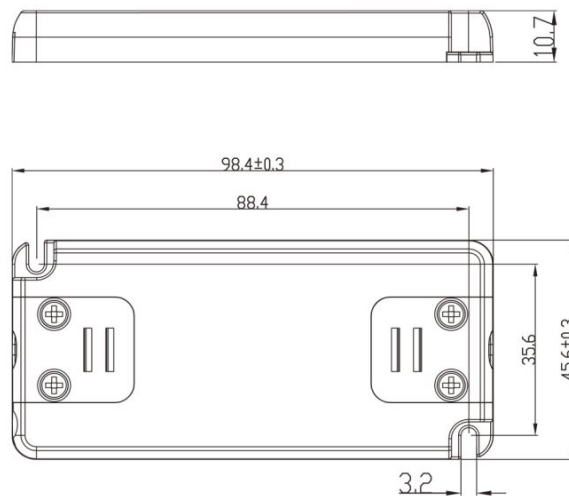

Foto:

